



## Small-Scale Bioenergy Initiatives:

Brief description and preliminary lessons on livelihood impacts from case studies in Asia, Latin America and Africa



## FINAL REPORT

January 2009

Prepared for PISCES and FAO by Practical Action Consulting



*Although this research is funded by DFID and FAO, the views expressed in this report are entirely those of the authors and do not necessarily represent DFID or FAO's own policies or views. Any discussion of their content should therefore be addressed to the authors and not to DFID or FAO.*

Published by: Food and Agriculture Organisation of the United Nations (FAO) and Policy Innovation Systems for Clean Energy Security (PISCES)

Copyright: 2009 FAO and PISCES

Citation: Practical Action Consulting (2009). *Small-Scale Bioenergy Initiatives: Brief description and preliminary lessons on livelihood impacts from case studies in Asia, Latin America and Africa*. Prepared for PISCES and FAO by Practical Action Consulting, January 2009

Case Study Project Manager: Steven Hunt, Practical Action Consulting, [steven.hunt@practicalaction.org.uk](mailto:steven.hunt@practicalaction.org.uk)

FAO Project Manager: Olivier Dubois, Climate Change and Bioenergy Unit (NRCB), FAO, [olivier.dubois@fao.org](mailto:olivier.dubois@fao.org)

Contributors: Fernando Acosta, Prof Sombat Chinawong, Becky Clements, Regina Couto, Milkyas Debebe, Mireille Ehemba, Tameezan Wa Gathui, Virginia Harden, Angela Higuera, Steven Hunt, Dr Smail Khennas, Gaston Lopez, Maria Lozano, Dr Tom Molony, Dr Fridah Mugo, Dr Ben Muok, Dr A Nambi, Ramani Nissanka, Ousmane Ouattara, Santosh Kumar Patnaik, Marta Rivera, Ramani Sankaranarayanan, Ella Sprung, Upamali Surangika, Pham Van Tanh, Ibrahim Togola

Cover photos: Main image:  
*Ethanol stove user, Ethiopia* (Photo: GAIA Association)

Insets from top to bottom:  
- *Harvesting Typha Australis, Senegal* (Photo: PERACOD)  
- *Charbriquette production using a rotor press, Senegal* (Photo: PERACOD)  
- *Masanga Women's Group: Acacia Tree Nursery in Madiany Division, Kenya* (Photo: Dr Fridah Mugo)  
- *Cooking on biogas* (Photo: Pham Van Thanh, CCRD)

Available from: Food and Agriculture Organization of the United Nations  
Climate Change and Bioenergy Unit  
Viale delle Terme di Caracalla  
00153 Rome, ITALY  
Fax: +39 06 57053369  
<http://www.fao.org/bioenergy/home/en/>

Policy Innovation Systems for Clean Energy Security (PISCES) Project  
Research Programme Consortium Lead Institution  
African Centre for Technology Studies (ACTS)  
Gigiri Court, off United Nations Crescent  
P.O.Box 45917 - 00100,  
Nairobi, KENYA  
Tel: +254-20 712 6889/90/94/95  
Fax: +254-20 233 9093  
<http://www.pisces.or.ke>  
[info@pisces.or.ke](mailto:info@pisces.or.ke)

## Executive Summary

This report is based on a series of 15 international case studies conducted between September and November 2008 under a joint initiative of FAO and the PISCES Energy Research Programme Consortium funded by DFID. The case studies focussed on developing an improved understanding of the linkages between Livelihoods and Small-Scale Bioenergy Initiatives. The study was developed in consultation with the PISCES Consortium Advisory Group (CAG). This is made up of leading international participants in the field of energy and development, including members from the IEA, UNEP, ENERGIA, DFID and FAO, as well as policymakers and research organisations in the PISCES target countries of India, Kenya, Sri Lanka and Tanzania.

The focus of the study was on the impacts that different types of local level Bioenergy initiatives can have on **Rural Livelihoods** in different contexts in the developing world. Livelihoods are understood as the enhancement of the full range of **natural, financial, human, social and physical capitals** on a sustainable ongoing basis.

The cases were selected from 12 countries in six regions of Latin America, Africa and Asia, and brief overviews of each case are provided in Chapter 3. They were selected to highlight the use of a range of Bioenergy resources, including natural **Bioresources**; **Bioresidues** from existing agricultural, forestry or industrial activities; and purpose grown energy crops, both liquid and solid, commonly known as **Biofuels**. The initiatives match these resources to a range of energy needs including cooking, mobility, productive uses and electricity for lighting and communication - thereby highlighting the scope of Bioenergy applications. The approach taken also considers the non-energy by-products of production processes where these form, or could form, a significant added benefit in terms of livelihoods, revenues and efficiency.

The case study approach has at its heart a **Market Systems** perspective, and in particular the use of Market Mapping. This approach enables the identification and illustration of the main **Market Actors** as well as the crucial **Supporting Services** and **Enabling Environment** which contribute to the success or failure of initiatives.

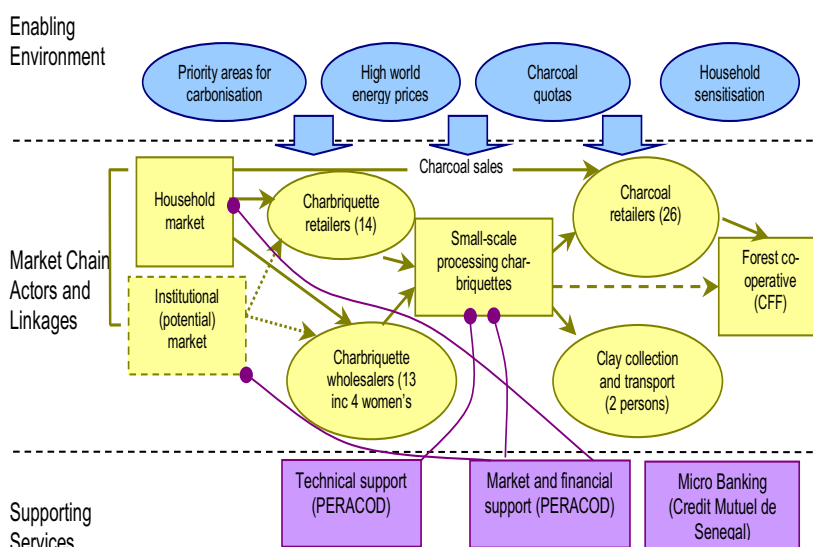

**Figure:** Typical Market Map (from the Senegal Char dust Briquettes' case study showing the three key components in the market model: the key **market chain, actors and linkages** (central band, yellow), the **enabling environment** (top band, blue), and the **supporting services** (bottom band, purple)

Taking the market map for each initiative as the basis, the project then applied the “4Rs” Framework of **Relationships, Rights, Responsibilities and Revenues** to the actors in the system. This approach aims to better understand the power dynamics of each case in terms of key issues such as risk, vulnerability, governance and equity.

Following this analysis, the **impacts** of each initiative on the Livelihoods Assets of the actors in the chain, and the sustainability of these impacts, were assessed and preliminary conclusions drawn.

**Tools** used in the research included field visits, surveys, existing literature, interviews and workshops, as well as the previous experience of researchers and contributors. In addition to the initiative leaders, consultees typically included participants, actors and beneficiaries. Details of the methodologies and tools used are provided in Chapter 2.

Chapter 4 of this report provides a **comparison and analysis of the cases**, drawing out some of their main characteristics and livelihoods impacts, including the following:

- **Market Systems** – Initiation methods, development strategies, wider linkages, enabling and support requirements.
- **Power Dynamics** – Leadership, participation, levels of formality, risk distribution, business models, institutional models, land and resource rights, intellectual property.
- **Human Capital impacts** - Capacity building in agricultural production and processing, entrepreneurship, producer/co-op/community organisation, improved health, reduced indoor air pollution, time saving, skills development and retention.
- **Social Capital Impacts** - Development of cooperatives, outgrower schemes, producer and consumer groups, collective initiatives for joint action and negotiation.
- **Physical Capital Impacts** – Production, processing and appliances, equipment, biomass capital.
- **Financial Capital Impacts** – New income generating activities from underused bioresources, increased revenues from processing of bioresidues, additional agricultural production income in biofuels initiatives.
- **Natural Capital Impacts** – realisation of bioresidue waste value, management of natural bioresources sustainably (within regrowth capacity), low impact agriculture utilising organic and natural cycles.

A summary is provided in Chapter 5 of **preliminary lessons and conclusions** which may be drawn from the case studies. It is hoped that these will inform and stimulate debate about the role of small-scale bioenergy projects in contributing to rural livelihoods. The preliminary lessons are summarised as follows:

- **Natural resource efficiency is possible in Small-Scale Bioenergy initiatives**
- **Local and productive energy end-uses develop virtuous circles**
- **Where fossil energy prices dominate, partial insulation is an option**
- **Longer term planning and regulation has a crucial role if Small-Scale Bioenergy projects are to succeed**
- **Flexibility and diversity can also reduce producer risk**
- **Collaboration in the market chain is key at start up**
- **Long local market chains spread out the benefits**
- **Moving Bioenergy resources up the energy ladder adds value**
- **Any new activity raising demand will raise prices, even those for wastes**
- **Cases do not appear to show local staple food security to be affected**
- **Small-Scale Bioenergy initiatives can offer new choices in rural communities**

The final section of the main report outlines **recommendations for further work**, building on the case outlines and preliminary conclusions to elaborate the challenges and opportunities of Small Scale Bioenergy initiatives at the local level more fully. These are:

- **Develop sustainability criteria for Small-Scale Bioenergy Initiatives**
- **Develop more detailed economic analysis for a selection of the cases**
- **Develop natural resource efficiency and energy balance assessments for a selection of cases**
- **Work on the incentives and constraints faced by farmers/rural people to adopting improved Bioenergy technologies and practices**
- **Develop understanding of the cases further from an equity and gender perspective**
- **Replicate and test the approaches taken in the case studies in other applicable contexts**

In addition to the **full text of cases** provided in Annex 1, a list of authors, contributors and editors is provided in Annex 2, while the full Terms of Reference for the study and the case study template are provided in Annexes 3 and 4.

# Contents

Executive Summary .....	i
Contents .....	iv
1 Introduction .....	1
2 Study Approach and Methodology .....	4
2.1 Case Selections.....	4
2.1.1 Selection Criteria .....	4
2.1.2 Case Study Countries and Regions .....	5
2.1.3 Bioenergy Type, Users, Uses and Vectors.....	7
2.2 Study Methodology.....	8
3 Overviews of Cases.....	12
4 Comparison and Analysis of Cases .....	20
4.1 Market Maps.....	20
4.1.1 Market System Initiation .....	20
4.1.2 Market System Development .....	22
4.1.3 Bioenergy as a component of wider Rural Market Chains.....	23
4.1.4 Enabling Environments .....	24
4.1.5 Supporting Services .....	25
4.2 Relationships .....	26
4.2.1 Leadership and Participation .....	26
4.2.2 Level of formality .....	27
4.3 Balance of Rights, Responsibilities and Revenues.....	27
4.3.1 Distribution of Risk .....	28
4.3.2 Business and Management Models .....	28
4.3.3 Land and Resource Rights .....	30
4.3.4 Intellectual Property.....	31
4.4 Livelihoods Outcomes .....	32
4.4.1 Human Capital.....	32
4.4.2 Social Capital .....	33
4.4.3 Physical Capital.....	34
4.4.4 Financial Capital.....	34
4.4.5 Natural Capital.....	36

5	Summary of Preliminary Lessons and Conclusions.....	39
5.1	Natural Resource Efficiency is possible in Small-Scale Bioenergy Initiatives.....	39
5.2	Local and Productive Energy End-Uses develop virtuous circles.....	39
5.3	Where fossil energy prices dominate, partial insulation is an option.....	40
5.4	Longer term planning and regulation will have a crucial role if Small-Scale Bioenergy projects are to succeed.....	41
5.5	Flexibility and diversity can also reduce producer risk.....	42
5.6	Collaboration in the market chain is key at start up.....	42
5.7	Long Local Market Chains spread benefits.....	43
5.8	Moving Bioenergy resources up the energy ladder adds value.....	44
5.9	Any new activity raising demand raises prices, even for waste.....	44
5.10	Cases do not appear to show local staple food security to be affected.....	45
5.11	Small-Scale Bioenergy initiatives can offer new choices in rural communities....	46
6	Recommendations for Further Work.....	48
7	Annexes.....	50
7.1	Case Studies.....	50
	Case 1 - Mali Jatropha Electrification.....	51
	Case 2 - Senegal Chardust Briquettes.....	56
	Case 3 - Senegal Typha Charcoal.....	61
	Case 4 - Tanzania Sisal Biogas.....	67
	Case 5 - Tanzania Palm Oil.....	72
	Case 6 - Kenya Afforestation Charcoal.....	77
	Case 7 - Ethiopia Ethanol Stoves.....	82
	Case 8 - India Jatropha Electrification.....	87
	Case 9 - Biodiesel based Water pumping program in rural Tribal villages of Orissa ..	92
	Case 10 - Sri Lanka Spice Drying.....	97
	Case 11 - Brazil Ethanol Micro-distilleries.....	102
	Case 12 - Guatemala Jatropha Biodiesel.....	107
	Case 13 - Peru Veg-Oil Recycling.....	112
	Case 14 - Thailand Jatropha Co-operative.....	117
	Case 15 - Vietnam Farm Biogas.....	122
7.2	List of Contributors.....	127
7.3	ToR for the Overall Case Study Activity.....	128
7.4	Case Study Template.....	131

# 1 Introduction

Today, 1.6 billion people still have no access to electricity and over 2 billion still rely on traditional biomass for the everyday cooking and heating needs which are fundamental to human life. However the very accessibility of Bioenergy to the poor represents part of a possible response to the challenge of increasing access to affordable energy services. Around the developing world there are examples of small-scale initiatives which are working to provide improved energy access through the development and transformation of various Bioenergy resources into cleaner and more convenient forms of energy at local level. The aspiration of these initiatives is however not just to provide energy access but also for the production of Bioenergy to power rural development through the creation of new Livelihoods opportunities. It is increasingly recognised that both improved energy access and the Livelihoods created through its production and use are essential if the Millennium Development Goals are to be achieved. Whether Small-Scale Bioenergy Initiatives can make a substantial and sustained contribution to these energy access and Livelihoods outcomes is the question which lies behind this study.

The Small-Scale Bioenergy Initiatives Study was developed jointly between PISCES and FAO addressing the common goal of improving understanding internationally regarding Small-Scale Bioenergy Initiatives and their impacts on rural livelihoods. Through the provision of brief descriptions and preliminary lessons on the livelihood impacts of a range of case studies in Asia, Latin America and Africa, it is hoped that some of the key challenges and opportunities of such initiatives may be better understood as a guide to future more detailed research, as well as ongoing and future initiatives in policy and practice.

Policy Innovation Systems for Clean Energy Security (PISCES) is a five year Research Programme Consortium funded by the U.K's Department for International Development (DFID). PISCES is working in partnership in Kenya, India, Sri Lanka and Tanzania to develop new knowledge and policies promoting energy access and livelihoods through Bioenergy. This new knowledge also contributes to the global debate on whether and how humanity should find more energy from Bioenergy sources, and how that pathway might affect the poor and the environment.

The Food and Agriculture Organisation (FAO) of the United Nations leads international efforts to defeat hunger and serves both developed and developing countries. FAO acts as a neutral forum where all nations meet as equals to negotiate agreements and debate policy. FAO is also a source of knowledge and information. The FAO Bioenergy Group is active in building the international knowledge base on sustainable exploitation of Bioenergy.



Practical Action Consulting (PAC) led the development of the case studies work along with PISCES research partners the African Centre for Technology Studies (ACTS), the University of Edinburgh and the MS Swaminathan Research Foundation (MSSRF). Case studies themselves were carried out by a combination of PAC and PISCES partner staff, local consultants and initiative participants, with management and co-ordination from PAC UK and Regional offices. A full list of contributors is provided in Annex 2.

The focus for the case study work on the linkage between Bioenergy and Livelihoods was developed in consultation with the PISCES Consortium Advisory Group (CAG) made up of leading international participants in the field of energy and development including from the IEA, UNEP, ENERGIA, DFID and FAO, as well as policymakers and research organisations in the PISCES target countries of India, Kenya, Sri Lanka and Tanzania. The feedback from this group was clear in that the contribution of these case studies would be most valuable in interrogating the extent and nature of the impacts that different types of local level Bioenergy initiative have on rural livelihoods in different contexts in the developing world. Livelihoods in this respect are understood as the enhancement of the full range of **natural, financial, human, social and physical capitals** on a sustainable ongoing basis.

In order to address this challenge, the study team selected cases from around the developing world, drawing on networks, contacts and existing literature to select a range of 15 international case studies from 12 countries in 6 regions of 3 continents. The cases were selected to highlight the use of a range of Bioenergy resources including natural **Bioresources, Bioresidues** from existing forestry, agricultural or industrial activities, and purpose grown energy crops better known as **Biofuels**. The matching of these resources to a range of **energy needs** including cooking, mobility and productive uses in addition to electricity for lighting, communication etc was specified to investigate the breadth and impact of Bioenergy applications. The approach also takes into consideration non-energy **by-products** of production processes where these form, or could form, a significant added benefit in terms of livelihoods, revenues and efficiency.

In between resources and end uses lies a sometimes complex series of processes and intermediate steps and in order to establish the full extent of these, the case study approach has at its heart a **Market Systems** perspective and in particular the use of Market Mapping. This approach enables the identification and illustration of the main **Market Actors** as well as the crucial **Supporting Services** and **Enabling Environment** which contribute to the success or failure of a given initiative.

Taking this market map with respect to a given initiative within a market system as the basis, the project then applies the 4'Rs Framework of **Relationships, Rights, Responsibilities and Revenues** to the actors and linkages in the system. This approach aims to better understand the dynamics of each case in terms of key parameters like risk,

vulnerability, governance and equity. This approach seeks to make the crucial differentiation between a job, and a sustainable livelihood in which rural people are participants and drivers of their own development.

With these aspects of the cases considered, it is then possible to draw preliminary conclusions on the extent to which Livelihoods capitals have been enhanced by each initiative, and what the prospects are for sustainability and expansion. Final preliminary conclusions can then be drawn on the wider impacts, prospects and main lessons of each initiative.

It should be clear that the cases selected are not intended to be inclusive of all types of Bioenergy development and neither are they necessarily recommended as ideal. Rather they are considered to be examples at the forefront of development in the Small-Scale Bioenergy sector in different respects, and as such offer windows into aspects of the emerging sector and guidance on what factors appear to be most important in delivering sustainable livelihoods objectives.

## **2 Study Approach and Methodology**

Full case studies are provided in Annex 1 of this report and Section 3 contains a series of introductory Vignettes on each. The full Terms of Reference for the study and case templates are provided in Annexes 3 and 4. This section provides some additional background and analysis on the case selections, countries and the case study methodologies employed.

### **2.1 Case Selections**

#### **2.1.1 Selection Criteria**

Cases were selected in consultation between PISCES and FAO on the basis of information gathered via networks, secondary literature, awards programmes and research and consultations to date. The criteria for selection were as follows:

- Cover a cross-section of Bioenergy types (Bioresources, Bioresidues and Biofuels) but with an emphasis on the emerging Biofuels sector which is relatively less developed and studied to date
- Cover a range of country and regional contexts including as a minimum Latin America, Africa, South and South-East Asia including both least-developed countries as well as rapidly developing economies
- Cover a range of End-Uses illustrating the different ways in which Bioenergy can provide energy services, with an emphasis on providing local energy services
- Focus on Small-Scale initiatives with a clear local participation, leadership and focus
- Cover a range of ownership, management and business models including fully commercial, co-operative, charitable and government supported

An Inception Report was presented in September 2008 and cases were agreed at that time in line with the criteria above. One of the key challenges in meeting the requirement to cover more cases in the biofuels sector is the relatively recent emergence of this sector which means that several projects selected are in the relatively early stages of implementation, and as such wider lessons are ahead. However, with this clear it was decided to go ahead on the basis that lessons from the design and initial responses to these projects are also of important interest to policymakers and programme developers in the sector, with these projects being in the vanguard of Small-Scale Bioenergy initiatives.

## 2.1.2 Case Study Countries and Regions

The map below indicates the 12 countries covered by the case studies in the six regions of Latin America, Africa and Asia:

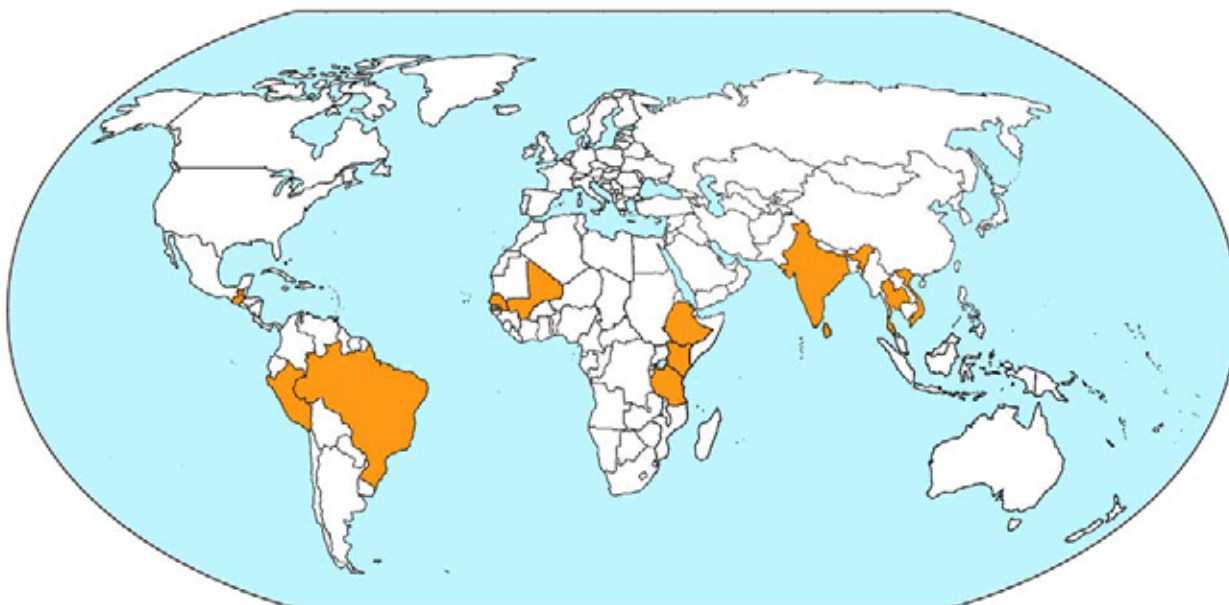

These countries represent a diversity of situations which are described at the local scale in the case studies themselves. However at the national scale, the situations are also very diverse in terms of populations, existing energy provision, Bioenergy resources, agricultural production and poverty, including food poverty, and many other indicators. The following figure presents the study countries in terms of estimates of their key energy access characteristics:

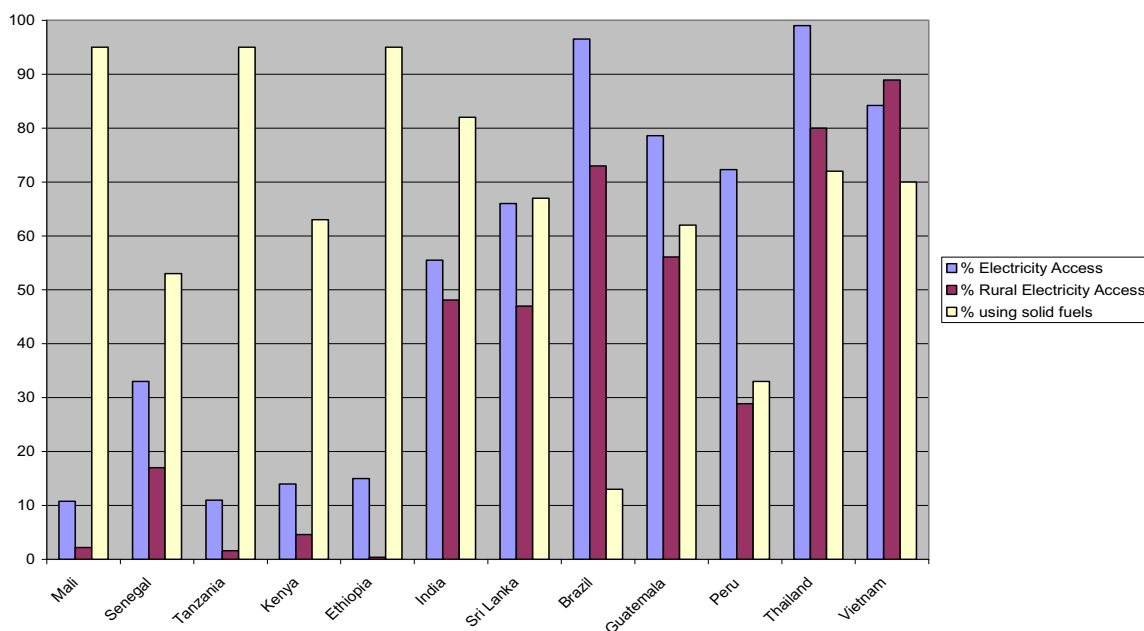

This graphically illustrates the existing very substantial reliance on solid fuels (primarily firewood although in some cases coal) for cooking in the study countries, even in the countries in which electrification has reached a relatively high level in rural areas. One of the starting points for this study is that this illustrates the vital role of Bioenergy in fulfilling basic household energy needs and that its availability and low cost makes it indispensable to the poor. However unmanaged felling of forests for firewood burned in unimproved stoves or charcoal produced in unimproved kilns, especially around urban centres, is known to contribute to environmental damage as well as health problems.

Another important set of properties of interest in the case study countries with respect to Bioenergy in particular are existing forestry cover and land under cultivation as estimated in the table below:

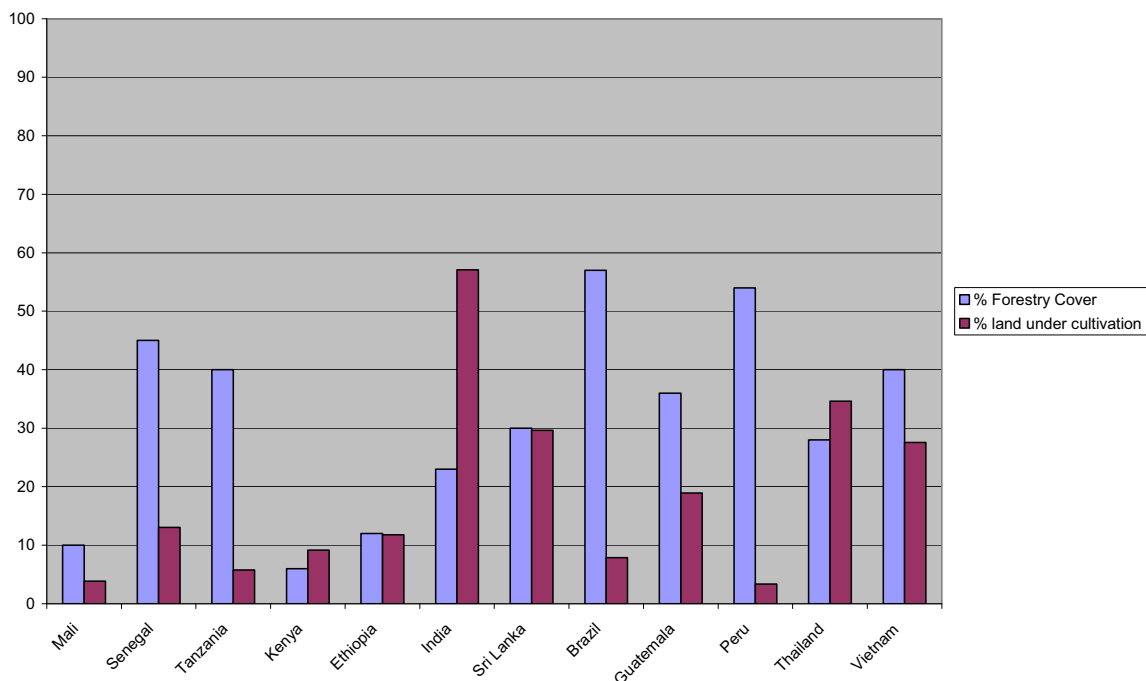

Forestry cover in the case study countries goes from as low as 6% in Kenya to as high as 57% in Brazil. At the same time percentage of land under cultivation goes from less than 4% in Peru up to 57% in India. These figures indicate the dramatically different situations in terms of Forestry cover, which could roughly be equated with natural Bioresources, and in terms of the proportion of land being currently farmed. This latter measure is a broad indicator for the extent of agricultural development in the country although it does not measure “available” land for cultivation which is an important variable in the Biofuels debate. These are clearly gross figures and the cases themselves provide more context of the regions within the countries where the initiatives take place, which often have very different profiles in terms of agricultural production and forestry cover compared with the national average.

### 2.1.3 Bioenergy Type, Users, Uses and Vectors

The 15 case studies cover energy services derived from a range of bioenergy resources as illustrated in the pie chart right. Natural Bioresources are defined as naturally growing plants which are not cultivated by humans in any way including natural forestry and river reeds for example. Bioresidues are defined as the wastes from existing agricultural, forestry or industrial activities including sawdust, husks, shells etc. Biofuels are defined as purpose grown energy crops and in this definition include oil and sugar crops for Biodiesel and Bioethanol, as well as plantations of trees for energy purposes including coppicing.

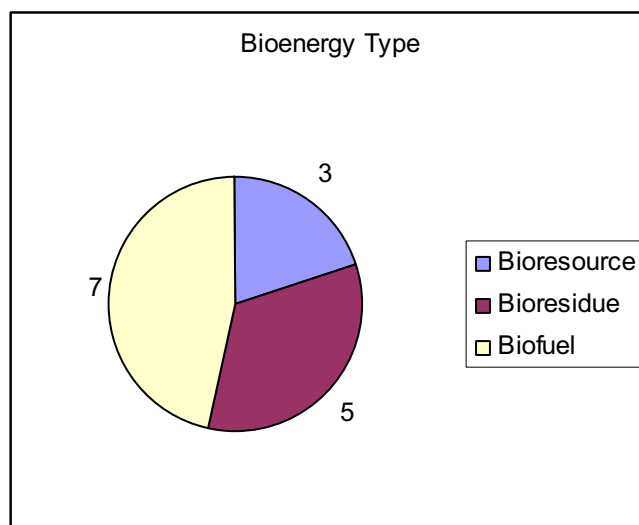

Although these categories, developed in consultation through the PISCES Programme, are useful, it was noted in the case studies that lines often blur between categories when considering whole market systems where combinations of feedstocks are used, and by-products mix with natural resources etc.

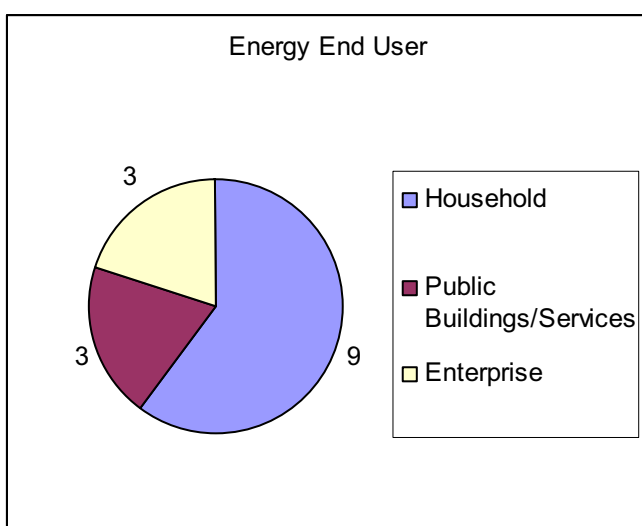

Of the 15 case studies, 9 of the initiatives are aimed at ultimately serving primarily household energy needs with the remainder split between use in enterprises as a means of production, or in public buildings or services. Services include mobility and transport in this case as well as water pumping and street lighting for example. In practice again there are usually overlaps between different types of use and for example electricity often supplies households as well as enterprises. However it is important to

note also that all cases selected emphasise local consumption of the end energy product or service. This will be shown to have important implications for distribution of Livelihoods benefits from the end product as well as from participation in the market system.

The types of energy end use are grouped as cooking, mobility, electrical appliances and production in the graph right with a roughly equal split of end uses between the 15 cases. Cooking is a significant use of Bioenergy by rural people in the case study countries and as such innovative initiatives for meeting this need, including use of Bioresidues and Biofuels for improved cooking fuels rather than natural resources, merit particular attention in this respect. Again in several cases there is spill-over between these categories with end-use selection, particularly in commercial projects, driven by relative pricing in different applications.

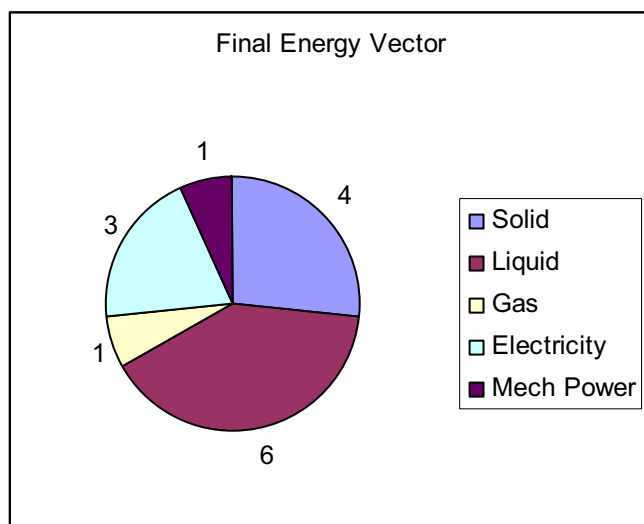
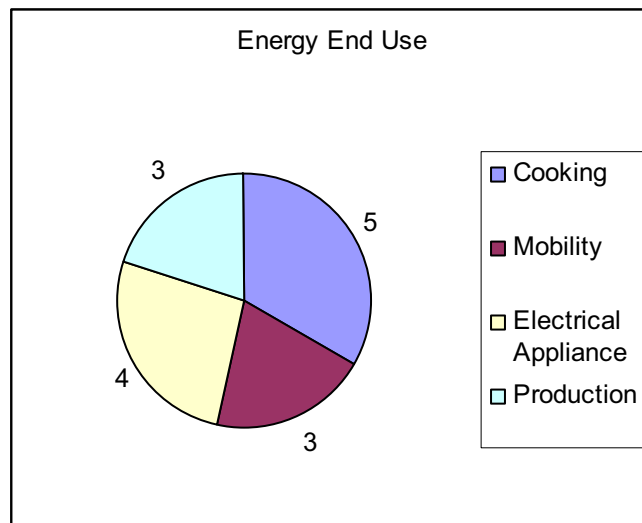

The final categorisation of cases which should be highlighted is the form of the energy at the point where it provides the energy service to the final consumer. In many cases the fuel may go through several forms via solid, liquid and gas for processing or transportation purposes before being converted into useful energy in the form of heat, electricity or mechanical power. The graph illustrates the selection of cases in showing a bias towards liquid which was selected in 6 of the 15 cases. This reflects the relatively

recent emergence of liquid biofuels as a significant factor in Bioenergy provision which had until relatively recently largely been dominated by solid fuel use. Advantages of liquid fuels in terms of flexibility and energy density are clear, as well as their linkages with agricultural production which imply important questions in terms of crop and land use selection.

## 2.2 Study Methodology

Understanding the full impact of Bioenergy systems on rural livelihoods requires improved understanding of the nature of the complete market chains, and of the different business models, technologies, institutional arrangements and power dynamics at the various stages in the chain, which can lead to very different livelihoods outcomes. PISCES conceptualises Bioenergy systems as energy pathways which may be illustrated as below:

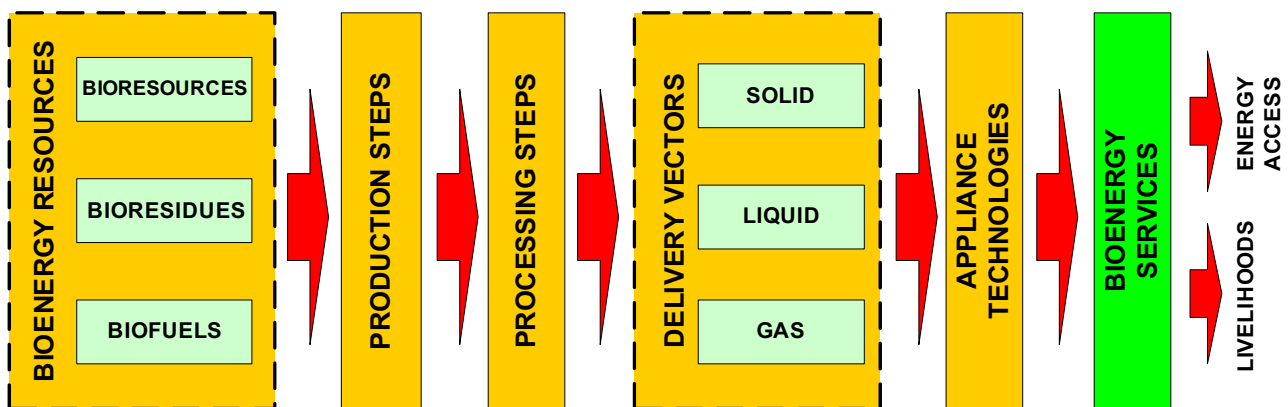

This diagram shows the various Bioenergy Resources and how they are converted ultimately into energy access and livelihoods outcomes. However, not only does the use of the energy result in Livelihoods opportunities via energy access and productive uses in enterprises, but each step and sub-step in the system (as well as wastes, co-products and supporting services) represents a separate livelihoods opportunity and has its own interlinked characteristics in terms of possible technologies, capacities required, financial implications, governance issues, access rights, risk characteristics, environmental impacts etc.

Building on this understanding, the methodology applied to each case, according to the ToR developed between PISCES and FAO and copied in Annex 3, was as follows:

- **Mapping the market/value chain of the initiative**

This step was primarily to ensure that all aspects of the initiative were accounted for in the later Livelihoods Analysis. The market mapping method employed drew heavily from that developed by Practical Action<sup>1</sup> and was developed using a combination of participatory, interview and research methods. These not only highlight market actors but ensure that Enabling Environment issues and Supporting Services to the market chain are captured since these also contribute to Livelihoods outcomes and provide broader information about the context within which initiatives are operating. In some cases there was initially concern from researchers or initiatives about whether a market chain actually existed but when prompted all realised that these existed even in the case where several functions were performed by the same organisation, and the systematic approach provided a new window into the wider connections of the project proponents with other organisations.

<sup>1</sup> [http://practicalaction.org/docs/ia2/mapping\\_the\\_market.pdf](http://practicalaction.org/docs/ia2/mapping_the_market.pdf)



- **Analyse the Relationships, Rights, Responsibilities and Revenues (4 R's) balance between the actors**

Based on the full range of actors identified through the market mapping the researchers were asked to consider the Relationships, Rights, Responsibilities and Revenues of the key actors in the market system drawing on the 4 R's approach developed by IIED.<sup>2</sup> This approach provides a structure for analysing power dynamics between actors as well as ensuring that all of these key aspects are covered for each actor. In this way important features relating to vulnerability and risk in particular can be addressed.

- **Assess the impacts of the initiative on the Livelihoods Assets of the actors in the chain, addressing also the sustainability of these impacts**

After an initial assessment of the vulnerability context for communities involved with initiatives presented in the background to each case and in the light of the full market map and 4R's analysis, researchers were then to identify the contributions of the project to the five Livelihoods Capitals of participants namely: Human, Social, Physical, Financial and Natural Capital. This approach utilised the Livelihoods Framework supported by DFID<sup>3</sup> and placed an emphasis on assessing where possible the sustainability of these impacts.

- **Draw conclusions on the impact of the overall initiative on Rural Livelihoods and lessons learned**

Finally researchers were asked to draw preliminary conclusions on the initiative and lessons learned which can then be compared with those of other cases and these are used extensively in this consolidation report.

Tools used in the research included field visits, surveys, existing literature, interviews and workshops as well as the previous experience of researchers and contributors. Consultees typically included participants, actors and beneficiaries from the market map as well as initiative leaders. The ToR for the case studies and the template for the presentation of the cases are common to all cases and provided in the Terms of Reference and Case Study Templates in Annexes 3 and 4.

Case studies in all regions were co-ordinated from the PAC UK office by Steven Hunt (Senior Energy Consultant and International Projects Manager, also interim PISCES Project Manager on behalf of ACTS). Responsibilities included co-ordination of inputs

---

<sup>2</sup> [http://www.policy-powertools.org/Tools/Understanding/docs/four\\_Rs\\_tool\\_english.pdf](http://www.policy-powertools.org/Tools/Understanding/docs/four_Rs_tool_english.pdf)

<sup>3</sup> [http://www.livelihoods.org/info/guidance\\_sheets\\_pdfs/section2.pdf](http://www.livelihoods.org/info/guidance_sheets_pdfs/section2.pdf)

from researchers, feeding back to researchers on case contents and compiling the final set of cases, as well as producing the consolidation report, including analysis and conclusions in consultation with the researchers.

Cases in West Africa, Latin America and South-East Asia funded by FAO were managed by PAC Regional Offices and staff with studies conducted by local consultants, initiative participants and PAC regional staff, supervised by the PAC Regional Management teams for Quality Assurance and oversight. Cases in East Africa and South Asia were funded by PISCES and conducted by PISCES partner researchers under QA and oversight of the PISCES partner leaders and the PAC UK Project Manager. The full list of case study researchers, managers and contributors is provided in Annex 2.

### 3 Overviews of Cases

The following vignettes provide outlines of the 15 cases and are numbered and renamed for quick and consistent reference by a three word title containing the country, form of Bioenergy and use/relevance. For the full titles of the initiatives please refer to the full case studies which are provided in full in Annex 1.

#### Case 1 - Mali Jatropha Electrification

The Garalo Project in Garalo commune, Mali, was established to provide the local community with access to electricity produced from Jatropha oil. Small-scale farmers are at the heart of the business model supplying Jatropha oil to a hybrid power plant. Electricity is then sold by the private power company ACCESS to residential and business consumers. Out of a forecast of 10,000 ha of Jatropha, 600 ha, involving 326 rural families, are already under cultivation on land previously allocated to cotton - a product which has significantly dropped in market value over recent years. The project provides a stable income to farmers as well as access to modern energy services for the community, both having stimulated the local economy. Furthermore, producer and consumer rights have been promoted through the establishment of co-operatives and associations.



One of three 100kW dutch generators at Garalo able to run on Jatropha oil, diesel or a blend (Photo: Smail Khennas)

#### Case 2 - Senegal Char dust Briquettes



Briquetting residues using the rotor press (Photo: PERACOD)

Action pour le Développement Solidaire), a private company. Although still at the pilot stage, sales of charbriquettes are growing rapidly, (e.g. less than 500 kg in November 2007, and approximately 2,000 kg in June 2008). With local

In Senegal, access to cooking fuel is a growing issue. This is because the reduction of quotas for biomass energy production and the reduction of forest areas devoted to it, along with the high cost of transport, high LPG prices and shortages, have coincided with reduced purchasing power of low income people due to rising inflation. In the city of Saint-Louis in North Senegal (population 160,000), access to charcoal is constrained by cost and scarcity as the city is hundreds of kilometres away from where people are permitted to make it. This initiative's approach to the problem is manufacturing charbriquettes from recycled low-value charcoal dust, which is locally available. With a favourable political climate, the programme is being driven, as a Public Private Partnership (PPP) by PERACOD (Promotion of Rural Electrification and Sustainable Supply of Domestic Fuels), a partnership between the Ministry of Energy and GTZ, and BRADES (Bureau de Recherche

authority support, employment is being generated, the briquettes are well-liked, polluting chardust is being cleared and used. Risks include an increase in the cost of raw materials, and the continued need for marketing.

### Case 3 - Senegal Typha Charcoal

Typha Australis is an invasive species that is found throughout the delta region of the Senegal River. Estimates suggest that there is the potential of 519,000 tonnes of dry biomass from Typha in the delta area. There are two main actors directly involved in the market chain; the company of four people who harvest, dry and process the Typha into briquettes, and a women's group which markets and sells the final product. The harvesting process is very demanding and as such investigation is ongoing into the options for mechanisation of collection of the Typha. Senegal benefits from a positive enabling environment with respect to renewable energies including Bioenergy and as such local authorities have welcomed the development of this project.



Harvesting Typha in a drainage canal (Photo: PERACOD)

### Case 4 - Tanzania Sisal Biogas

Tanga region in Tanzania depends on sisal as its most important cash crop. Using current production methods, only 4% of the actual plant is recovered as fibre, the residue either burnt, producing carbon dioxide, or rotted naturally, producing methane. At Katani Ltd, a sisal growing and processing company, this residue is now converted to biogas, and thence to electricity, used to power the factory and excess power can be used by those living on company premises. Further plans include doubling the power output from 150kW to 300kW, and developing biogas for vehicles and piping fuel to households.



Sisal processing machinery (Photo: Katani)

Katani Ltd. has strong social interests and has transferred land to local farmers on which they grow sisal which they buy. The increased income has enabled them to build better houses, buy bicycles, mobile phones and better clothes, along with access to electricity and cleaner drinking water. Electricity is used to provide light for work in non-daylight hours, and to run small-scale industries, which can subsequently increase incomes. Katani provides energy services to the local schools and hospital. It is difficult to assess the full impact of the Cleaner Integral Utilisation of Sisal Waste for Biogas and Biofertiliser as only phase one has been completed. However, higher standards of living, alongside increased levels of employment have already decreased rates of migration from rural to urban areas.

## Case 5 - Tanzania Palm Oil

Based in Kigoma town, Western Tanzania, FELISA is a Limited Company cultivating 4,358 hectares of palm trees and processing fresh fruit bunches for crude palm oil. Oil may be processed into biodiesel and expected to be sold in the domestic transportation market. Given the high market value of crude palm oil however, FELISA is considering supplying the edible oil and cosmetics /pharmaceuticals markets. FELISA are distributing high oil yield seedlings to 29 farmers' groups (comprising about 990 farmers) and to date they

have given around 10,000 seedlings for free. The company has developed an outgrower scheme

through which small-scale farmers in regional villages will be contracted to supply additional fresh fruit bunches to help meet demand once FELISA's own plantations bear fruit. Furthermore, the outgrower scheme will provide extension services to improve production techniques and assist with the establishment of small-scale processors.



Palm oil processing (Photo: Thomas Molony)

## Case 6 - Kenya Charcoal Afforestation

Kenya's forest resources cover only around 6% of the country's 58.2 million hectares and are estimated to be decreasing by 2% annually. Firewood is mainly a rural fuel with over 90% of Kenya's rural population dependent on it. Charcoal made from wood, on the other hand, is produced by rural people as a source of income. Charcoal is mainly an urban fuel, with 82% of the urban population using it. In 2002, the Youth to Youth Action Group, with financial support from



Masanga Women's Group Acacia Tree Nursery in Madiany Division

Thuiya Enterprises Ltd., initiated the community-driven commercial afforestation project, using two types of Acacia tree to make charcoal, in order to enhance the livelihoods of the local communities. Charcoal has previously been thought of as only semi-legal, so those involved in this initiative have to overcome social barriers to manufacture it. There is a high level of collaboration between several groups of actors, with legal contracts ensuring that each party gets paid for their efforts. The project has already increased forest cover significantly, and

training in farming skills has enabled the farmers to earn short-term income through fast-growing

crops and honey production. Farmers can sell wood directly, but need permits for charcoal production. On the negative side, most men sign the contracts with their sons, rather than with their wives, and levels of corruption are still a cause for concern. The project looks positive, but a critical mass is needed before sustainability can be assured.

## Case 7 - Ethiopia Ethanol Stoves

Ethiopia is one of the poorest countries in the world and the most widely used fuel for cooking in the capital, Addis Ababa, is kerosene (42.2%) followed by fuelwood (29.4%). Charcoal, LPG, electricity and residues are used by a much smaller section of city households. Recently, the number of people cooking on kerosene dropped dramatically, exacerbated by the government taking away the subsidy. Ethiopia established an ethanol manufacturing plant at the Finchaa sugar factory in 1999. Seeking potential markets for the ethanol, Project Gaia was invited to do pilot studies in Addis Ababa households in 2004. Since then, Gaia has been working to promote ethanol as a household energy fuel in both the city and in neighbouring refugee camps, where it is partnered by UNHCR



Stove user talking about the CleanCook stove (Photo: GAIA Association)

which buys the ethanol stoves. Results of a pilot study have showed that the project households readily accept the new cooking technology (a stove called the 'CleanCook'), and ethanol fuel, and that ethanol could effectively substitute for kerosene, for charcoal and for fuel wood use, where the cooking task could be completed with the ethanol stove. Gaia has been working with Makobu Enterprises PLC to produce CleanCook stoves in Ethiopia for around five years. The two partners have a bilateral agreement that has helped them to work on establishing a local stove manufacturing plant. Benefits include reduced fuelwood use, with consequent reduced risks for those gathering fuel, reduced indoor air pollution, time and money savings for those using the stove, locally-available fuel saving imported kerosene, and employment in manufacture and distribution of stoves and ethanol.

## 8 India Jatropha Electrification



Woman collecting Jatropha seeds (Photo: Winrock International India)

The Ranidehra rural village electrification initiative of Winrock International India (WII) is to electrify a remote tribal village through the use of biofuel in the state of Chhattisgarh. The objective of this initiative is to demonstrate the technical and financial viability of running diesel generation sets using vegetable oil as fuel in place of conventional diesel to provide electricity. The initiative aims to design and implement a replicable model of remote village electrification via use of Jatropha as feedstock. The experiments undertaken in WII proved the use of Jatropha oil in conventional diesel engines as fuel instead of converting into Biodiesel. In the predominantly tribal village 110 households are accessing 3 hours of domestic and 3.5 hours of street lighting per night using 1 tonne of Jatropha

seed per month. The project continues to evolve over time with weaker elements being addressed and improvements made. The initiative establishes the idea of rural electrification through active community participation. The promotion of small scale village energy generation helps to boost the village economy by providing alternative livelihood opportunities.

## Case 9 - India Biodiesel Waterpumping

Orissa occupies around 5% of the total geographical area of India. It occupies an important place in the country having a high concentration of Scheduled Tribe (ST) and Scheduled Caste (SC) populations. The biodiesel-based water pumping project is being implemented in the remote and tribal belts of two neighbouring Ganjam and Gajapati districts in Eastern Orissa. This initiative led by CTxGreEn, a Canadian not-for-profit organisation, and Gram Vikas one of the largest NGOs in the state of Orissa, India, involves biodiesel-based water pumping primarily for sanitation in 4 villages. This was later extended into critical irrigation of crops through a bioenergy system that eventually led to regeneration of land resources



Pedal-driven biodiesel reactor (Photo: CTxGreEn)

and improved livelihood opportunities. A biodiesel production unit uses the local underutilised seeds of *Pongamia pinñata*, *Madhuca indica* from Forest and *Guizotia abyssinica* (Niger) as feedstock. Biodiesel is produced using a pedal powered reactor for grinding oil seeds, pressing oil from seeds and getting biodiesel from the oil. The biodiesel can be used in the regular pump-sets and generator sets. The press is hand operated while the grinder and biodiesel reactors are pedal operated. The local community uses the by-products, such as pressed oil cake and glycerine, as natural fertilizers and cattle/poultry feed. Although this project is successful on a small scale, and has established the technical feasibility, there is concern that fragile village level institutions, vested political interest, and the absence of strong local level governance could prove to be challenging on a larger scale, particularly as the technology lends itself to enabling social change.

## Case 10 - Sri Lanka Biomass Spice-Drying

The introduction of 19 wood-fired dryers by Alliance for Appropriate Technology Exchange (AfATE) to village level operators in Kandy District has diversified income streams and increased revenue to a range of local actors operating within the spice production market chain. As well as selling by-product fuel wood from pepper plants to the dryers, small scale growers are now also able to sell mature spices which can be dried and preserved. These are sold by the driers to the European and Western export markets where they fetch premium prices. In addition, the installation of biomass driers has stimulated a local fuel wood supply chain including one commercial seller and numerous home growers.



Spice drying racks (Photo: Practical Action)

## Case 11 - Brazil Ethanol Micro-Distilleries

This initiative has two components: the testing of ethanol cook stoves in households and the development of Micro Distilleries of Ethanol (MDE). The testing of the 'CleanCook' ethanol stoves in households has taken place in three



areas of the Minas Gerais state of Brazil. Stove users have reported benefits ranging from a reduction in smoke and safety improvements, to time and cost savings. The ethanol was originally given to households at no cost, and the price was progressively increased up to market prices. The second component of the project involved the development of the micro distilleries and had two aims: to make ethanol available at a reasonable price in local communities, and to strengthen livelihoods of the producers. The legislative framework plays an important role, and has the potential to enable or frustrate the workings of the MDE market.

Community-owned micro distillery of ethanol (Photo: GAIA Association)

## Case 12 - Guatemala Jatropha Biodiesel

The Ministry of Agriculture of Guatemala has identified 600,000ha of land across the country that is considered suitable for the growing of Jatropha. This project was established early in 2008 and is situated in Cuyotenago in Guatemala covering 170ha of land, which is owned by a total of 150 families, and is projected to produce 361,000 litres of Jatropha oil per year. The farmers will be organised into clusters by a co-operative, the first cluster has already been set up. For this first cluster the processing equipment to transform the oil into usable fuel is owned and operated by an industrial partner, but in future it may be owned by the co-operative. The



Jatropha plantation (Photo: Technoserve)

The processing of the oil also produces products that can be used variously for cosmetics, and fertiliser. The project receives technical, organisational and business development support from TechnoServe, a global organisation whose aim is to support small entrepreneurial development.



## Case 13 - Peru Veg-Oil Recycling

This case covered two individual entrepreneurs who have set up in the business of producing biodiesel from used vegetable oil in Lima in Peru. The main way of accessing the oil is through restaurants and supermarkets. The business



Mr A Jacobo with the current biodiesel reactor  
(Photo: Practical Action)

is run on an informal basis as the formalisation process appears to be too complex and expensive for small producers to manage. Once the biodiesel has been produced by these small enterprises, it is sold (again on an informal basis) to end users, with the end user sometimes being the same establishment that the used oil originally came from. Training has been provided by Practical Action to ensure the quality control of the end product and thus improve the confidence of the customers. With the situation as it stands, biodiesel production is not a very profitable activity in Peru but initiatives have been able to continue over 10 years, still in the hope that their contribution to resource efficiency and fossil fuel substitution will be recognised in regulation or financing systems.

## Case 14 - Thailand Jatropha Co-operative

In 2006, the University of Kasetsart and the Viengsa Agricultural Co-operative initiated a zero-waste Jatropha development project in Viengsa District, Northern Thailand. The University and the Co-operative have played a key role, not only in establishing and supporting market actors but also in facilitating the sale of products at highly competitive prices (lower than on the open market) to consumers within the Co-operative. The University is running a Jatropha School to train Co-operative members in Jatropha production, processing and marketing. For its part, the Co-operative has formalised agreements between members to guarantee and fix prices of raw materials and Jatropha products. To date, the project has not only provided an



Seedling preparation (Photo: Univ. of Kasetsart)

income to 1,000 farmers but has also established local access to an affordable and renewable source of energy to help the community reduce the costs of production and thereby increase energy and food security.

## Case 15 - Vietnam Farm Biogas

Vietnam has one of the fastest growing economies in the world. Following land rights being given to individual farmers, the country embarked on an integrated land management scheme, supported by the Vietnamese Gardener's Association (VACVINA), which works at all levels, and has national responsibility to promote this concept – called the VAC integrated system. It involves gardening, fish rearing and animal husbandry to make optimal use of the land. Traditional fuels such as wood and coal for cooking, are becoming increasingly scarce and expensive, and can contribute to deforestation. Increasing livestock production in rural communities with high population density leads to health and environmental issues from the quantity of animal dung being produced. Biogas digesters are part of the solution offered by this initiative, using the wastes to generate energy, and the resultant slurry as a fertilizer to improve soil quality. A market-based approach has been adopted to disseminate the plants. The service provided to those buying the digester is comprehensive. The customer must have at least 4-6 pigs or 2-3 cattle that provide all the inputs (animal dung). Households use the biogas as fuel and slurry as fertilizer. They pay the total installation cost for the digesters to local service providers, and operate the biodigester using instructions provided by local service providers. A biodigester produces enough daily fuel for cooking and lighting. It improves the surrounding environment, whilst livestock produce meat, milk and fish products for local consumption and subsistence farming. Vegetable production is enhanced through use of biogas slurry. Latrines can be added to the



Cooking on biogas (Photo: CCRD)

system to enable human waste to be used for energy.

## **4 Comparison and Analysis of Cases**

### **4.1 Market Maps**

The following sections highlight features of the Market Maps developed for each case study to compare different approaches and their contribution to successful start-up and development of the Small-Scale Bioenergy Market Systems, as well as their actual or likely impact on rural livelihoods.

#### **4.1.1 Market System Initiation**

In tracing back the initiation of the market systems for the cases, an interesting range of initiators and initiation strategies have been uncovered. In general although there is often an individual or institutional driving force, in all cases a coalition of interested parties has been established in order to initiate projects and initiatives, which have in turn led to the establishment of new market systems. These coalitions have been required to overcome barriers to the establishment of initiatives which in general cannot be solved by one institution alone.

Even in the cases where the lead initiator has been a private company such as in the Tanzanian Sisal Biogas case or Sri Lanka Biomass Spice-Drying cases, there has been crucial support from development donors to enable technology development and piloting. In cases such as Guatemala Jatropha Biodiesel and Kenya Charcoal Afforestation initiation has been by NGOs, but with integral partnerships with local private companies. In all cases the support of local and/or national government from relatively early stages has also been important in removing legal barriers. In several cases, most notably the Thailand Jatropha Co-operative, the involvement of Universities has been important in supporting technology research and development in particular. In many cases where significant numbers of farmers or outgrowers are involved, the involvement or indeed initiation of CBOs, co-operatives or producers associations has been a key feature in getting initiatives off the ground.

In this respect it is not possible to say based on these case studies that a particular initiation model for small-scale Bioenergy initiatives has proved most effective, but rather that in order to overcome barriers to establishing a local bioenergy market system a combination of capacities, resources and authorities is required. While this is true, the role of committed individuals within organisations and within communities themselves can also be easily identified within several cases, in providing visionary leadership and coalition building skills in initiating projects.

The moment of initiation for different projects varies and is of course open to interpretation, but in general this can be considered to be the point when a first round of financing or funding is obtained and activities start in earnest to break barriers and create a new reality

in which the initiative is possible. Funding and financing for initiatives covered in this study is very diverse and includes private, donor, government, community and charitable funding, often combined in varying proportions and discussed in section 4.1.5 below.

Some of the key activities involved with initiation seen in the case studies covered include:

- **Co-ordination** – In all cases a key initial activity has been the building of the initiating coalition whether that involves farmers, donors, technology providers etc. This is usually required before financing is obtained but continues immediately after as the initiative gains momentum.
- **Capacity Building** – In all cases training and capacity building has been a primary activity and catalyst for initiatives. In some cases such as the Kenya Commercial Afforestation case and all Jatropha projects, the initial training is regarding production processes such as planting, seedling care etc. In cases where the primary material (often Bioresidues) is available such as Brazil Bioethanol Micro-Distilleries or Peru Oil Recycling, the capacity building is mainly regarding processing steps. In others where the fuel is already available such as Ethiopia Bioethanol Stoves, the training focus is around the appliance technology. In other cases, particularly chains built from nothing, such as Mali Jatropha Electrification, training is provided at all stages.
- **Technology Transfer** – In several cases the transfer of a key processing technology has enabled the initiation of a project. In the Senegal Charbriquettes example it was a new rotor press, in the India Biodiesel Water-Pumping case it was a Mafuti Mali Oil Press (from Kenya) and in the Guatemala Jatropha Biodiesel example it was Oil Extraction and Transesterification Equipment. In many cases these have been subsequently modified for local use but where similar crops are used elsewhere, importing corresponding processing equipment has been found to be an important leapfrogging step in creating a new market chain.
- **Marketing/Outreach** – In many cases in order to build support for an initiative or indeed customers for a new more environmentally-friendly energy product or practice, marketing and outreach has been practiced by initiatives. This can involve free or cut-prices samples such as in the Brazil Bioethanol Distilleries case or the Vietnam Farm Biogas case. In several cases most notably in the Senegal Typha and Charbriquette cases a separate entity, a women's co-operative in Senegal, was involved in the project to be in charge of marketing to reach out to more consumers and spread benefits from the product sale.
- **Feasibility Study** – In all cases some type of feasibility study has been carried out to a greater or lesser extent. These were noted as important features of the Senegal Typha Charcoal and Guatemala Jatropha Biodiesel cases in particular.

- **Seedlings** – In most Small-Scale Biofuels examples a crucial initial step has been production and distribution (often for free) of seedlings whether they are Jatropha as in Mali or Acacia as in the Kenya case. This reduces barriers to entry for small farmers, should increase crop quality and survival where proper selection and quality control is carried out, and can be an important first step in developing trust and collaboration between actors.
- **Soft Loans** – Instead of providing seedlings or means of production free, in some cases including the Thailand Jatropha Co-operative case, soft loans were given through the co-operative instead to initiate production.

#### 4.1.2 Market System Development

The market systems covered in this study can be seen to be in very different stages of development with some having been established up to 10 years ago while others are have started only early in 2008. The stage of development of a chain is a crucial parameter in assessing the success of a model in contributing to Livelihoods in a sustainable way and this is a challenge in conducting studies such as this on the emerging Biofuels industry in particular. As can be seen from the cases covered, many are in relatively early stages and as such longer term sustainability issues are yet to be seen and have strong interactions with larger global trends and issues such as oil prices, evolution of EU subsidies and climate change policy and financing responses. However, as initiatives grow in size, especially likely in cases possibly linked with larger global markets or companies such as Guatemala Jatropha Biodiesel or Tanzania Palm Oil, new opportunities and threats are presented in terms of potential revenues as well as risk and price pressures on producers. Co-operative set-ups and local production and consumption chains such as Thailand Jatropha Co-operative and Mali Jatropha Electrification are less exposed to both these risks and revenue opportunities, but still have significant growth potential in terms of coverage within rural areas and spread of co-operative systems without interacting with global markets.

In general it can be said that the longer established market systems like Tanzania Sisal Biogas, there are more and different actors involved in the main chain compared with more recently established chains. Emerging pilot chains such as Mali Jatropha Electrification and Senegal Chardust Briquettes tend to be more integrated with a smaller number of players taking key roles (or multiple roles) in the main chain. As Bioenergy market chains develop it can be seen that the chains tend to grow and diversify in numbers of actors at all levels, even in the cases where Co-operatives or relatively insulated market systems are concerned, provided an energy demand remains and the enabling environment and supporting services remain in place. In systems where Bioenergy is one component of a separate chain, such as in the Sri Lanka Biomass Spice-Drying case, the expansion of the

market system will be led by end markets for the main chain product. In all cases this growth in numbers of rural participants deriving their livelihoods from Bioenergy is an important measure of the impact of Small-Scale Bioenergy Initiatives on livelihoods discussed in Section 4.4.

### 4.1.3 Bioenergy as a component of wider Rural Market Chains

As noted in the previous section, it is important to distinguish between the different roles of Bioenergy in the larger Market System in order to establish the impact on Livelihoods. The role of Bioenergy in the cases covered fall into one of the following categories:

- **Bioenergy as the main output of the chain** – This is the case for all Biofuels initiatives as well as Bioresources cases established to serve household cooking, mobility and electrical applications. Energy demand is relatively constant in that people cannot do without energy and must find it somewhere to serve their basic needs. In this respect it forms a stable demand with growth potential in response to better, cheaper and more convenient sources, while in some markets the environmental impact of the fuel is also a relevant criterion.
- **Bioenergy as a productive input to another chain** – In cases such as Sri Lanka Spice Drying, the Bioenergy forms an input to another market chain helping enhance its competitiveness and increasing efficiency. In this case the Bioenergy chain is reliant for its end market on the other productive chain and the Bioenergy market chain is governed by the requirements and success of that chain.
- **Bioenergy as a by-product of another chain** - This is the case for all Bioresidues initiatives such as Peru Veg Oil Recycling and Tanzania Sisal Biogas. In these cases the likely extent of the bioenergy market chain is also limited by the size of the main market chain which governs the amount of residue by-products available.

All the roles above are viable for Bioenergy initiatives and are being exploited in small-scale initiatives as can be seen from the cases selected. Where improved Bioenergy serves an energy end-use within rural communities (either as the main output or as a by-product) it makes a direct contribution to rural energy access and quality of life. However, given the importance of productive uses in creating jobs and incomes, the contribution of Bioenergy as an input into other chains is also of great importance and can make a greater contribution to rural economic growth.

#### 4.1.4 Enabling Environments

The prevalent Enabling Environment for Bioenergy varies dramatically between countries and indeed between types of Bioenergy within the same country. Some important components of Enabling Environments which came out strongly in the case studies are as follows:

- **Government Regulation/Incentives**

In all cases Bioenergy regulation falls across the jurisdictions of regulatory authorities with Ministries of Energy, Rural Development, Agriculture, Forestry, Water, Land, Rural Electrification etc, often being found to have overlapping responsibilities. Additionally in most cases regulation of Bioenergy can be seen to be in a state of flux as competing interest groups argue over the correct direction for different types of Bioenergy development, particularly as sector profile has grown with high oil prices, energy security and climate change debates. In general a focus on the liquid biofuels sector has dominated discussion about regulation and incentives in comparison with the Bioresources and Bioresidues sectors which are often ignored as being the domain of the poor. Regulation in these sectors has historically been limited to restrictions on forestry use, waste dumping or charcoal production without the offering of alternatives, often forcing production underground. However this is changing and regulation on sustainable Bioresource and Bioresidues use is notable in the Kenya and Senegal cases for example. In Sri Lanka, Bioresources have been recognised as a key national energy asset to be used and managed as a counterbalance to fossil energy import reliance.

Regarding Biofuels, in some countries regulation is developed and supportive such as in Thailand and Guatemala which favour Biofuels development with tax incentives and subsidies although this is targeted mainly at the large scale. In Brazil the Ethanol case shows that regulation on Bioethanol for transport is highly developed but to the exclusion of household use, which is a challenge to energy access initiatives. In other countries such as Kenya and Peru Biofuels legislation is still in development and as such existing initiatives operate in a regulatory vacuum which is an important source of instability, risk and limitation to the sector.

- **Standards**

Another important Enabling Environment factor noted in the case studies related to regulation is the availability, appropriateness and enforcement of relevant standards for Bioenergy. In several cases such as Kenya Charcoal Afforestation and Peru Vegetable Oil Recycling the lack of standards on Bioenergy products such as oil and charcoal tend to lead to a lack of trust and respectability in the sector. A lack of standards on products also applies to the production processes and no sustainability criteria can generally be enforced

if these mechanisms are missing. However in cases such as Guatemala and in India where standards are in place, this can be an important enabling factor.

- **World Oil Price**

An element of the Enabling Environment arising again and again in the case studies is the Oil Price. In this most international of markets, Bioenergy projects in particular are often linked to international oil prices. This linkage can be weaker or stronger depending on local arrangements in terms of tax and transportation costs leading to widely varying prices for oil products such as kerosene, diesel, LPG and petrol which compete directly with Bioenergy in most demand segments. The viability in particular of liquid biofuels projects is linked to diesel and petrol prices, however as a tiny fraction of this market and serving people who have very limited access to these resources in normal situations anyway, most small-scale Biofuels projects covered by this study have chosen to insulate themselves from the larger market at least in the initial stages while processes are improved.

#### **4.1.5 Supporting Services**

Supporting services which enable the main market chain to function cited in the case studies included **financing/loans**, **factors of production** such as fertilizer and machinery, **transportation**, **legal and contract** assistance, **Technology R&D**, **bargaining support**, **training** and **capacity building**, **market information** provision, **marketing** and others. These services are drawn upon by various actors in the chains and some, such as training, are most important at the beginning of the development of a market chain while some, such as transportation, are required on an ongoing basis.

Supporting services are provided in some cases by departments within market actors but in most cases are provided by organisations not directly within the main market chain. These can include NGOs, such as in the Guatemala Jatropha or India Biofuel Water-pumping case, Government agencies such as in the Senegal Typha and Chardust cases, Universities such as in the Thailand Jatropha Co-operative case, or private actors providing more standard services such as transport or construction.

**Marketing** is a key supporting service to the success of a market chain and is sometimes provided by market actors themselves and sometimes by supporting services providers such as NGOs or Government etc. It is often through marketing that market actors can have an influence on the Enabling Environment by creating awareness and changing public perceptions as consumers and voters, which can in turn influence purchasing trends and policy.



**Funding and Financing** are also clearly crucial to the success of small-scale initiatives especially given that they are often functioning in weak rural markets where lack of capital in particular is a key constraint. Approaches employed in the cases covered vary from primarily government and donor support such as in the Mali Jatropha Electrification, and Thailand Jatropha cases, to mainly private such as in the Tanzania Palm Oil case. As might be expected the donor and government support is stronger in cases where rural development including energy access is emphasised, while private financing is stronger where more lucrative export markets are involved. However, all cases covered involve a combination of financing from market chain participants, private (local, national or international) financiers, government and donor agencies and all lay varying levels of emphasis on development, environment and economic outcomes. As such these cases can be said to represent positive examples of projects taking the perspective that these are mutually reinforcing. The extent to which this remains the case over time will be the test of the sustainability of the project and the scale-up models which they pursue.

## **4.2 Relationships**

Given the importance identified of coalitions or partnerships in starting and developing Bioenergy Initiatives, relationships are a crucial feature of initiatives and the following section notes some key factors linked to relationships within initiatives and market systems which have come out of the case studies.

### **4.2.1 Leadership and Participation**

All case study initiatives have what could be described as leaders of the initiative which are an NGO in the case of the Ethiopia Ethanol Stoves case, a private company in the case of the Tanzania Palm Oil case and a University in the case of the Vietnam Jatropha Co-operative case. In all cases also it is possible to identify charismatic individuals within these leading organisations who provide crucial impetus as well as providing a nexus for interest and collaboration on the initiative.

However as noted in the section above, none of the initiatives is wholly dependent on one organisation and all have clearly spent time developing participation and support for the initiative within other linked stakeholder groups and between other actors in the market chains. This focus has enabled the cases to gain as a minimum of sufficient local support, government support and funding support to progress. Particular features include the encouragement of co-operative and producer group formation in many cases, even where the project is led by a private sector company such as in the Tanzania Palm Oil or Sisal Biogas cases. Other approaches include the use of Public-Private Partnerships such as in the Senegal Charbriquette cases.

## **4.2.2 Level of formality**

A range of levels of formality have been noted in the case study approaches which appear to be very dependent on contract enforcement regime in the country. Most notably in the Kenya Afforestation Charcoal case initial investment in seedlings and tree plantations by a private partners working with an NGO was lost after it became clear that contracts on sale of the final product would not be honoured and highest market price at the time would be taken by the growers. However at the same time agreed prices and contract adherence have been seen to be key to reducing risk and encouraging co-operation in many other cases including the Tanzania Sisal Biogas Case and the Mali Jatropha Electrification case. This is especially significant in these cases as outgrower models are used with initial investment from the end user in the outgrowers so if that is not honoured then not only is the investment lost but the security of supply (Sisal or Jatropha oil to the generator) is compromised and the whole initiative may fold.

In this instance processors, producers and appliance partners in some of the cases can be seen to recognise the importance of the other players in the chain and are supporting them in their stability and strength such as through assisting in the creation of both producer groups such as in Tanzania Sisal Biogas, and user groups in the case of Mali Jatropha Electrification. In these contexts negotiation of relationships and formal arrangements tend to have more likelihood of success on all sides, although wider circumstances, such as commodity prices and loans are still a factor.

In many cases as can be seen from the Relationships tables on page 3 of the cases, a combination of formal and informal arrangements are made throughout a market system so for example a fuelwood supplier may guarantee contract supply to the Spice Dryer in the Sri Lankan case, but in turn the supplier will have a series of informal relationships with fuelwood collectors which will not be under contract.

## **4.3 Balance of Rights, Responsibilities and Revenues**

Analysis of the balance of Rights, Responsibilities and Revenues of the actors in the initiative market systems provides a window into the power dynamics of a market system which in turn offers a perspective on where vulnerabilities lie. The reduction of vulnerability amongst rural populations and producers is a key element of the Livelihoods impacts which the study seeks to address and main points emerging from the case studies are discussed in the following sections.

### **4.3.1 Distribution of Risk**

A crucial measure of vulnerability is the extent to which livelihoods are at risk. Risk is a function of the likelihood of an event transpiring (such as a crop failure or natural disaster) and the seriousness of that event (such as whether a crop failure wipes out an entire livelihood, or whether a family has another income or food sources or reserves). In this respect keen attention is required in a market chain as to who carries the risk of failure. In the case where this is small scale rural producers without alternative livelihood options, this can be seen as a direct threat to security of livelihoods.

All the initiatives covered in this study claim to have addressed these issues in spreading risk between larger players and smaller actors through a number of mechanisms. Diversification is common and in all biofuels cases the projects encourage intercropping of energy crops with food crops, via trainings and practical assistance, and the use by small-farmers of only currently unproductive land (in the case of Guatemala Jatropha Biodiesel for example). In cases where there is a time delay in bioenergy production, the initiatives encourage or promote additional growing of short rotation food crops and honey (such as in the case of the Kenya Afforestation Charcoal project).

Risk for small producers also arises from isolation and lack of awareness about wider market signals and prices. In this respect the initiatives encourage co-operative setup and producer groups enabling joint bargaining, pooling of resources for mechanisms such as bridging loans, and bulk purchasing for reduced costs of production. All of these act to reduce risk for each producer. This approach can be beneficial throughout the chain since Bioenergy processors, buyers and investors are also at risk where producers are unstable, contract enforcement is weak and bargaining is with individuals. These factors can damage security of supply and raise transaction cost as well as costs of production if new suppliers must be sought.

With guaranteed pricing such as in the Mali Jatropha Electrification and Ethiopia Ethanol Stoves cases for example, risk is shared as long as joint bargaining and communication is in place between producers, processors and consumers. The timeframes of such agreements are important to enable adequate market flexibility within affordable price bands, as well as security over the longer term for Bioenergy producers and consumers.

### **4.3.2 Business and Management Models**

Rights, Responsibilities and Revenues are reflected in the Business and Management models applied by initiatives, whether they apply to one main actor within the chain or to an umbrella organisation such as a co-operative within which most functions of a market chain occur. The Business Models discussed in this section are those targeted as the

end-goal of the project even if they are currently operating in different mode. Again, several model types are in evidence in the case studies with many facets. However they can broadly be said to fall into the following categories:

- **Fully Commercial – Wider markets**

In the cases of the Tanzanian Palm Oil, Tanzanian Sisal Biogas and Guatemala Jatropha Biodiesel the models are designed such that in normal operation they will be fully commercial in terms of the relationships between market actors and if higher prices are offered for products in international markets these may be exploited. The initiators are working on the assumption that mutual self-interest on the part of the various market chain actors will enable the continuation and development of the chain. This is expected to bring new investment and income into rural communities, however risks are entailed on all sides since at any time a higher offer to producers (from another purchaser such as a large oil company) or a dip in the international market (a drop in the oil price for example), could cause the chain to collapse since other factors such as environmental protection and rural development will not be explicitly priced in. Additionally, pressures to go to larger scales, reducing costs (ie revenues to producers) and reducing direct energy access benefits in the area (ie all products are exported to higher value markets) may be inexorable.

- **Fully Commercial – Local Markets**

Some initiatives such as the Senegal Charbriquettes and Chardust cases, the Kenya Afforestation Charcoal project and Peru Oil Recycling cases operate on a fully commercial basis but are only expected to serve local sub-national markets. In these instances linkage of the energy benefits to local populations is clear and although exposure to wider markets remains, a more localised market more closely linked with the producers themselves is targeted. It is notable that these are the markets normally engaged in by rural producers. Initiatives focussing at this level have an advantage as long as the Bioenergy product is sufficiently better than alternatives in terms of price, quality, convenience or perception. It is notable however that the projects in this section are for lower grade energy products than the liquid fuels which are found either in the Fully-Commercial Wider Markets or Semi-Commercial categories. Outside revenues are also limited and competition from less environmentally sound but more convenient sources is ever present as noted in the Senegal and Kenyan cases.

- **Semi-Commercial**

Market systems which arise between organisations and individuals within a co-operative such as in the Vietnam Farm Biogas case or the Thailand Jatropha case, or within constrained regulatory circumstances in terms of subsidy or market restrictions such as in the Mali Jatropha Electrification or Ethiopia Ethanol Stove cases, can be described as semi-commercial. In these cases profit is made by all actors and money changes hands in proportion to market rates. However these are insulated from wider markets and prices are controlled within agreed bands. These systems are generally less attractive to external

private finance support but also place higher emphasis on rural development outcomes and stability for participants in the chain. Initiatives following this model could be described as social-enterprises and are more generally eligible for ongoing donor or government support at some level. Another feature of this model is that access to the services is generally restricted to members of the Co-operative or within the restricted system and wide membership is needed if benefits are to spread.

- **Volunteer**

The only case based on an element of volunteerism or self-help is the India Biodiesel Water pumping case which employs a “Sweat-Equity” approach whereby participants work in collection of oil seeds or operation of the oil press to earn participation in the benefits of the scheme. This enables participation in the initiative by extremely poor individuals and communities, but also implies very limited involvement of the private sector and potentially limitations on scale up in communities with better, although still limited, access to finance and means of production.

Within each of the above general models there is of course a wide range of sub-models and leadership and responsibility systems. It is also argued that to some extent the choice of model depends on the circumstances and traditional organisational systems within the countries, and this is undoubtedly true. That said, in cases where the Enabling Environment is conducive, the cases covered here would imply that Local Market oriented and Semi-Commercial approaches are offering the most direct energy access benefits to rural areas. Whether broader livelihoods benefits can be brought via increased income through connection to wider markets depends largely on the terms of that connection, and on the point at which it is made in terms of the development of the market chain.

### **4.3.3 Land and Resource Rights**

Land and Resource rights are a crucial concern, particularly in Bioenergy projects involving cultivation of energy crops or access to natural Bioresources. In the situation of Bioresidues, rights are usually clear and lie with the previous processor of the residue, be it from forestry such as the Senegal Charbriquettes case, agriculture as in the Tanzania Sisal Biogas case, or industry as in the Peru Veg Oil Recycling case.

With respect to Land Rights, different situations are again notable in the cases covered, varying primarily by country based on the land reform and allocation systems within each country, and sometimes between each actor in the chain. From the perspective of the security of rural producers the cases fall into the following categories:

- **Land ownership of small farmers secure** – In the Guatemala Jatropha Biodiesel case for example the Government has previously allocated land to small-farmers as

is the case in the Vietnam Biogas case after the Doi Moi reforms initiated in the 1980's

- **Lease or Usufructuary rights available to small farmers** – In the Mali Jatropha Electrification case small-farmers, as is typical in Mali, have usufructuary rights on the land, which means that short-rotation crops can be grown, but this poses a problem for longer term plantations (including Jatropha bushes). In the Tanzania Sisal Biogas for example small farmers have a lease on land issued by the company on condition of adherence to a contract negotiated with producer associations.
- **Unclear or no Land tenure** – In cases where natural resources are used which are not clearly owned by anyone, such as the Senegal Typha Charcoal or India Biofuel Waterpumping cases, generally collection operates in a grey area until extraction reaches a certain level. Specifically in the Indian case restrictions of removal of resources from forestry is a key constraint and dispensations for indigenous dwellers have to be sought.

Case initiatives appear to have sought to work within local constraints on land and resource rights, and in building the necessary coalitions of support for small-scale initiatives have had to negotiate these issues with the local people, local government and the various relevant departments of national governments, as noted in section 4.1.4 on Enabling Environments. Typically this has involved a number of Ministries, and sometimes overlapping legislation regarding land, natural resources, processing and distribution rights, and several initiatives note challenges in terms of gaining the clarity on these rights required to secure investments.

#### 4.3.4 Intellectual Property

Intellectual property was mentioned as a key issue in a minority of cases which may be because the production or processing equipment in most cases is one part of the wider initiative with the equipment often bought or adapted from a company as part of the cost of establishing the market chain. However in some cases, particularly where the initiative has as a major component transfer of a specific technology and has significant private involvement and investment in the R&D, then Intellectual Property and patent rights are a relevant issue. This is the case for example in the Sri Lanka Spice Drying case, where the dryer was the key technology which opened up a new chain, and the Ethiopia Ethanol Stoves case, where patent protection has been sought to protect private investments in the CleanCook stove as well as in the development of the stove manufacturing facility in Ethiopia. None of the Biofuel cases involved any intellectual property around plants or seeds.

## 4.4 Livelihoods Outcomes

This section focuses on the general lessons which can be drawn from the cases in terms of their broader contributions to Rural Livelihoods. It draws as far as possible from the full range of activities and actors involved with each market system, including supporting services providers and enabling environment actors where relevant. It should be noted that conclusions in this section on Livelihoods outcomes are based only on the small-scale initiatives covered in this study, and do not necessarily apply to other or larger initiatives. It should also be reiterated that the early stage of many of the initiatives precludes assessment of long term benefits at this stage.

### 4.4.1 Human Capital

The main factor cited in the case studies in terms of an increase in Human Capital is undoubtedly that of training and capacity building amongst the rural producers, processors and consumers. All Small-Scale Bioenergy Initiatives covered have involved significant training, capacity building and human development support to encourage increased and full participation in the initiatives. The skills involved are not limited to practical skills regarding production and processing of Bioenergy, but also in several cases concern the efficient running of a small business and entrepreneurship. Additionally the establishment or support of co-operatives, producer associations and consumer associations, such as in the Kenya Afforestation and Tanzania Sisal cases, creates opportunities for learning about and gaining experience in the running of civil society organisations representing rural people and communities.

Additional to the benefits of participating in the initiative, in the cases such as Mali Jatropha Electrification and India Jatropha Electrification where modern energy access improvements in the local area are integral to the initiative, an increase has been noted in the access to information, health and education services. This is partially due to the availability of energy for lighting for studying at night, vaccine refrigeration and communications for example, but also because the retention rate of skilled and professional people such as health care workers and teachers increases when improved energy services become available. The transformational effect of this type of energy access, and the feeling of modernity and connection which it involves, have been noted to raise confidence, alongside the confidence that accrues from being involved with a successful small business activity, co-operative management and sustained income generation. These can be expected to have knock-on effects on entrepreneurship, community organisation, and new ventures in the future.

All five of the cases focussed on improved cooking fuels note the significant reduction or removal of the drudgery associated with collection and use of firewood, releasing human capital usually spent in these ways, particularly by women, to other uses. Particularly

good examples of this include the Vietnam Biogas example where it is estimated that 50-80 person days per household per year are saved by that initiative. Additionally the introduction of cleaner burning fuels into households, such as Ethanol stoves in Ethiopia and Brazil, also reduce indoor air pollution by 93%, dramatically reducing the associated health problems which kill over 1 million people per year globally (according to WHO statistics), and impose a general drain on human capital, especially women and children, through poor respiratory health. Cleaner burning fuels also significantly reduce build up of soot on pots which require scrubbing, an additional time saving noted in the Vietnam case to be highly appreciated by household cooks, typically women.

#### **4.4.2 Social Capital**

Participation in the small-scale Bioenergy Initiatives, whether in co-operatives, outgrower societies or as independent participants in a collective initiative is consistently shown in the cases to build social capital within rural communities. This seems to be a very important component in many rural schemes either during initiation or subsequently when the initiatives start to take hold. For example through the establishment of the Mali Jatropha Electrification initiative both village and commune level co-operatives have been established with keen participation from local farmers while at the same time an Electricity Consumers Association of energy users has been established enabling representation of users. The development of joint action societies through the case initiatives within rural areas has also been shown to bring improved co-ordination and greater voice to rural people which in turn has helped them to interact with higher authorities such as government agencies and donors in addressing other issues faced by the community. A particularly good example of this is the Kenya Afforestation case where the associations established through the project are negotiating also now with cotton and rural development agencies.

In addition to the rural institutions developed through the initiatives, access to modern energy itself is also shown to play a major role in enabling social interactions after dark and establishing new social opportunities and as such also acts to build social capital. Street lighting in the cases involving electrification show this most clearly.

In the case of Vietnam Farm Biogas another benefit noted by participants is the increased level of cleanliness associated with containing and digesting animal manure. Not only does this enable the rearing of an increased number of animals on the same land without health issues associated with animal dung but additionally smells and flies do not invade neighbours space which has been noted to improve relations between neighbours, a highly important factor particularly from a cultural perspective in Vietnam.



Social capital between rural producers is the underpinning of effective joint negotiation and action which is a key factor in these producers gaining better deals within market systems and in their interactions with intermediaries or larger processors. The cases show that where this is encouraged, it can bring benefits for all participants in the chain building the trust and co-operation relationships which are required for effective development of market systems.

### 4.4.3 Physical Capital

The main increase noted in the cases in terms of physical capital is in processing equipment enabling the conversion of bioresources, bioresidues and biofuels into improved bioenergy services. These include for example improved efficiency kilns in the Kenya Afforestation case, oil seed expellers in the India Jatropha and water pumping cases, transesterification equipment in the Guatemala Biodiesel case, micro-distilleries in the Brazil Ethanol case and briquetting presses in Senegal.

In addition to processing equipment, in some cases improved appliance technologies are an important physical capital component such as in the Ethiopia Ethanol Stoves case, the water pump in the Indian Biofuel case and generating sets in the Mali Jatropha Electrification case.

Increases in physical capital do not only derive from project interventions themselves in production, processing and appliances, but also from the increased income to farmers who in turn invest more in their own physical capital. For example small producers in the Tanzania Sisal Biogas case have been observed to invest in labour saving machinery for or additional income generating opportunities such as livestock to increase labour and land productivity, activities also noted in the Vietnam Farm Biogas case.

### 4.4.4 Financial Capital

Sustainable increase in financial capital is built in different ways depending on the initiative type and the nature of a participant's interaction with it. Taking existing activities as a baseline it is useful to consider the different ways in which different types of bioenergy project contribute to increasing financial capital:

In **Bioresources** projects, financial capital is built primarily through the creation of new income generating activities based on existing, previously under or non-utilised natural capitals. For example in the Senegal Typha Charcoal case revenues are being generated from the production of charcoal from an invasive river species while in the Sri Lanka Spice Drying case abundant and fast growing *Gliricidia* growing in gardens and farms is being

used to add value to the Spice chain by displacing expensive imported fossil fuels and improving quality over sun-drying which has to occur in the wet season. Financial revenues are therefore created in jobs in these new market chains in production and processing as well as in access rights to the resource.

In **Bioresidues** cases financial capital is mainly increased through an increase in revenues to the original processor who now receives additional income for a previously waste resource such as in the case of the char dust sold from charcoal yards in the Senegal Charbriquettes case or from the sale of waste vegetable oil in the Peru case which restaurants and hotels would previously have had to pay to have removed. In cases such as the Tanzania Sisal Biogas case where the organisation uses the Bioresidues itself as a means of production they then save on fuel bills, again increasing the viability of the business. Additional revenues are also of course created for participants in the businesses involved with the processing and retail of the Bioresidues themselves such as the charbriquette sellers in Senegal.

In **Biofuels** cases there are even more mechanisms and opportunities for increased financial capital gain since not only are processing and retail functions available for wealth creation but also production of the material itself which is not counted in Bioresidue or Bioresource projects. In this respect there is evidence from the Biofuels cases of additional revenue to small farmers for production of energy crops either instead of cash crops such as cotton in Mali, or from currently unused farmland in the Guatemala case, or intercropping with food crops as in the Thailand Jatropha case. Additionally there are the opportunities for new jobs created on farms now made viable by the new end market, such as in the Tanzanian Palm Oil case.

In addition to the opportunities above specific to the type of bioenergy resource in question, there are also other more general financial capital opportunities which are being harnessed or developed by the cases covered:

- **Carbon Finance** - is still a developing revenue opportunity for Small-Scale bioenergy projects but in the Ethiopia Ethanol Stoves Initiative it will be used to subsidise stoves to low income families while potential for carbon financing has also been noted in the Indian Biodiesel Water pumping case.
- **Income Security** - is a crucial factor in a sustainable livelihood and this is a feature of several initiatives including Mali Jatropha Electrification, Tanzania Palm Oil and Thailand Jatropha Co-operative which provide contracts and price guarantees for production. The security of this has real value to rural producers and can enable other productive investments via loans for example.

- **Government Support** – is forthcoming in a number of cases supporting the viability of Bioenergy projects driven by a policy imperative to reduce macro-level balance of payments deficits caused by fossil fuel imports. At the macro level the production of liquid biofuels in particular has clear potential to address cash outflow on imported oil which can make up a very substantial proportion of national GDP in several of the case countries covered, which has knock-on effects on financial capital available in the country.
- **Reduced running costs** - associated both with provision of services from imported diesel. For example savings in costs for water pumping in the India water pumping case, and in households energy costs in the case of the Vietnam Farm Biogas.
- **Bioenergy by-products** – In several situations there are by-products of the Bioenergy processing systems which also have market value for example Glycerine from Biodiesel production in Peru is sold to cosmetics firms or processed by the community themselves into soap in India for example. An additional by-product is fertilizer produced by biogas systems in the Tanzania Sisal and Vietnam Farm Biogas cases as well as from seed-cake in the Jatropha cases such as in Guatemala. This is either used directly by participants such as in Vietnam to increase yields or sold as a product to other farmers in Guatemala.
- **Premium on associated products** - Food produced with organic fertilizers derived from Bioresidue or Biofuel processing can attract higher market prices and this has been noted particularly in the Thailand Jatropha case.

#### 4.4.5 Natural Capital

The Small-Scale Bioenergy cases covered by this study also demonstrate a number of contributions to natural capital through various approaches taken or features of the rural market chains established. Again there are different impacts on natural capital which are associated with different types of Bioenergy project:

In the **Bioresidues** cases natural capital existing in waste by-products is realised through improved processes to become a new type of capital which was previously underutilised, non-utilised or actually polluting. These include the large amounts of choking chardust in the Senegal case, sisal waste in the Tanzania biogas case previously rotting and emitting methane, Vegetable Oil in the Peru recycling case which was previously dumped, and waste molasses used to produce bioethanol in the Ethiopia example which would otherwise be a river pollutant. In none of the Bioresidues cases does it appear that a residue previously going to use in soil nutrient enrichment or other use has been diverted to Bioenergy to the detriment of natural capital. The natural capital impact of the

production of the original product is not covered by the cases since in all cases this would be occurring whether the Bioenergy project was happening or not.

In the **Bioresources** cases it appears clear that an abundant natural capital is harvested in a manner which does not exceed the carrying and regrowth capacity of that resource and in fact acts to manage that resource in some cases within reasonable limits. For example the Senegal Typha Charcoal case involves the harvesting of an invasive river weed estimated to have a wet mass of 3 million tonnes in Senegal which is clogging watercourses, having a detrimental effect on river flora and fauna health and which in any case has a regrowth rate which is well ahead of any projected extraction rate under the initiative. In this case the net result is to reduce pressure on woodland by replacing with a more abundant resource not associated with other beneficial features such as restricting soil erosion. In cases such as the Sri Lanka Spice drying case, fast growing *Gliricidia* is used and as long as this continues to come, as it does now, from rural home gardens and forest management including replanting it should not have a negative impact on natural forest resources.

In **Biofuels** projects the potential for reduction in natural capital is greater as with any agricultural activity, however in the small-scale bioenergy cases covered here there is no indication that this is taking place and that instead benefits of natural resource management are being realised. In the case of Kenya Afforestation the energy crop growth has served to increase forest cover by 200 hectares while trees are leguminous fixing nitrogen and improving soils compared with when the areas were bare or with thickets. In this case, as well as in the *Jatropha* cases, using indigenous trees serves to avoid upsetting ecological balances while the micro-climate is improved by forests and a new carbon sink is created. In the liquid biofuels projects clear statements are made by the participants that crop selections are suited to marginal non-forested lands and to be used on these or intercropped with other food crops to avoid conflict with existing natural capital or food production. Additionally organic fertilizers produced as by-products of oil-seed pressing are reintroduced to the soil which increases fertility and soil health as well as reducing polluting run-off into rivers from inorganic fertilizers. If these standards are maintained these small-scale initiatives should continue to make a positive contribution to increasing natural capital in rural communities.

In addition to these contributions specific to the type of bioenergy resource in question, there are some additional contributions to natural capital made by the cases more generally:

- **Reduction in forest depletion** - in cases focussed on addressing cooking needs in developing communities, whether in the Kenya Afforestation Biofuel case, the Senegal Charbriquette Bioresidue case or the Senegal Typha Bioresource case, a primary benefit of the project is to reduce pressure on forests for cooking fuels. By

replacing unmanaged forest depletion with new resources or more efficient use of existing resources an important contribution is made to protecting forests which are a key natural capital resource providing multiple environmental services and under pressure globally and specifically in several case study countries as clearly visible in the graph in section 2.1.2

- **Substitution of fossil fuels** – fossil fuels are one of the most precious natural capitals available on the planet and in all the Bioenergy cases covered, plant resources which are renewable if managed properly are used in place of irreplaceable fossil fuels thereby reducing pressure on that resource. This does not in any way address inequitable access to fossil fuels, but cases highlighted offer windows into how Bioenergy resources can partially or completely replace some of the energy services people need in a world where access to fossil fuels is becoming increasingly difficult, expensive and ill-advised from a climate change perspective.

## **5 Summary of Preliminary Lessons and Conclusions**

There are many lessons contained in the case studies provided in Annex 1 and in addition there are many further questions which could be asked and will be asked of these initiatives over the coming years as some of them mature further and market conditions change locally and in the broader environment. With the early nature of some the biofuels cases in particular, care must be taken in drawing conclusions about the longer term sustainability of the initiatives. With that said, the following is a list of preliminary conclusions which may be drawn from the cases at this time, which it is hoped can contribute to informing debate on the contribution of Small-Scale Bioenergy Initiatives to Rural Livelihoods.

### **5.1 Natural Resource Efficiency is possible in Small-Scale Bioenergy Initiatives**

The cases studies all emphasise whole cycles of resource production, processing, and application including reuse and recycling of by-products. In Bioresidues cases new energy value and use is put to wastes which would otherwise rot, pollute or be burnt thereby increasing the resource efficiency of the production cycle. In Bioresource cases alternative natural resources are harvested and used more efficiently at sustainable extraction levels replacing fossil fuels. In Biofuels cases intercropping and use of marginal land for hardy crops and trees appears to create new natural and financial capital with cycles of growth and use of by-products as fertilizer contributing to new growth and soil fertility.

In these ways and more described in more detail in the cases, approaches are being developed in Small-scale Bioenergy Initiatives which incorporate technologies, knowledge and practices offering high levels of natural resource efficiency. The extent of this for a selection of initiatives, which generally do not have strong quantified analysis on this topic, could usefully be further analysed as discussed in Section 6 of this report.

### **5.2 Local and Productive Energy End-Uses develop virtuous circles**

In all the cases covered, even those with a commercial orientation towards a wider market in the longer run, a focus on providing improved energy services in the producer regions is clearly in evidence. In the market mapping and livelihoods analysis the benefits that flow from the use of the improved energy within the local communities are key in delivering livelihoods benefits through improved energy services in households, communal spaces, public buildings, services and enterprises. Direct uses contributing to improved quality of life are important for building human and social capital in particular while use in enterprises for productive uses has the added benefit of developing additional financial capital within

communities which supports ability to pay tariffs for the energy services which in turn support the viability of the Small-Bioenergy Initiatives.

In this way virtuous circles of development are shown to develop within communities enabling access to the energy services needed for development without money flowing out of the community for fossil fuels or drawing down local natural resources. As strength of communities and initiatives grow, some mention that wider markets may be a source of new revenue which may enable a further step out of subsistence production. However, cases covered in this study focus on local markets first, which appear more stable in general and less open to distortion by foreign governments and firms, and with an appropriate enabling environment this strategy appears to develop more cyclic and distributed benefits to livelihoods than an export-first orientation.

### **5.3 Where fossil energy prices dominate, partial insulation is an option**

In almost all cases cited fossil energy prices are a dominant factor in the Enabling Environment and much of the enthusiasm in the Bioenergy sector, especially amongst the private sector, can be traced to recent historically high fossil fuel prices. This is particularly the case in the Biofuels sector, but also slightly less directly across the whole Bioenergy sector. For example a removal of subsidy on kerosene in Ethiopia drove an increase in unimproved fuelwood use in the country. This dominance is not a new situation and in many countries significant biofuels developments have taken place over the last 30 years or so since the first oil crisis. In general these have fallen by the wayside as fossil fuel prices dropped, with the notable exception being Brazil which persevered in bioethanol development with government support.

In some of the Small-Scale projects covered in this study a primarily economic argument is made for Bioenergy production based on the high fossil energy price. In all however evidence is presented about wider benefits of local production and consumption of a resource derived from the sun, earth and water. These benefits take the form of human, social, natural and physical capital gains, which are not seen by communities or priced in to fossil fuel use. In this respect a strong argument is made in several initiatives for partial insulation of the market chain and this has been done at local level through co-operatives, social structures or local by-laws. This has especially been the case in emerging technology sectors to enable community Bioenergy projects to establish themselves, protected from the relatively unstable, externally regulated and distorted world fossil fuels markets which in any case were generally only partially accessible in the rural communities concerned.

## **5.4 Longer term planning and regulation will have a crucial role if Small-Scale Bioenergy projects are to succeed**

In any emerging sector which offers potential social and human benefits which are not currently priced into a market system, and especially in the Bioenergy sector where that market system is the dominant fossil fuels sector, it is likely that planning and regulation to support the development of these benefits will be required based on a longer term vision. Longer term trends which governments in the case countries are notably responding to in planning and regulation include diminishing supplies and increasing competition for global oil supplies, and longer term environmental degradation locally in terms of forests and globally in terms of climate change. Emerging recognition of these trends are shown in the cases to drive policy interventions that create market potential for the stable development of new Bioenergy sectors among more vulnerable rural communities where for example agreed pricing systems can provide the stability required for longer term productive investments by reducing risk cost. This type of stability is also shown in the cases to attract local capital and private sector involvement and to reduce the vulnerability of rural producers to wider market forces which they are ill-equipped to respond to.

Another regulatory issue coming through in the cases which is key to biofuels developments serving local energy access is the issue of “leak-through” of Bioenergy products”, particularly liquid biofuels, into unproductive uses of richer consumers particularly cars. Several project cases considered for this study were found to have run aground because a rise in the fossil fuel price had forced locally produced biofuels out of rural energy access markets and into richer consumer automobiles. Cases selected show how local action by local-government, co-operatives and producer groups have created agreements which retain the energy product within the rural energy market system at prices which work for producers, processors and users such that energy benefits are not lost but spread more widely and put to productive use in agricultural machinery for example. Even where a target market is vehicle transport, all cases selected show mechanisms where access to the energy service is enabled for rural producers, households and co-operative members.

However, the functioning of systems such as this, whether regulated from local or national level and through whatever organisational system, requires an adherence to contracts enforced both from local levels within communities and from the general legal system. This is a key challenge in many countries, but several of the cases provide optimism that, within market chains that are at least partially delimited within systems incorporating representation and negotiating power for rural producers and consumers, social and legal contracts can be strong factors in supporting mutually beneficial and efficient market relationships.



## **5.5 Flexibility and diversity can also reduce producer risk**

While stability in terms of pricing for Bioenergy products can be an important source of resilience and an enabling factor in investment for rural producers or collectors, another common theme visible in the cases is the importance placed on flexibility and diversity in the face of changing market and environmental conditions. All Biofuels projects covered involving rural producers incorporate strategies such as intercropping of various food and other cash crops along with Bioenergy, which provide different natural characteristics in terms of pest and drought resistance and maturation and harvesting times for example, as well as different market characteristics in terms of demand or self-consumption. These measures are intended to promote both income and food security through diversification and risk minimisation and appear to be compatible with supporting regulation and tax systems for example on the Biofuel crops.

These strategies are generally most relevant for Biofuels and particularly in cases where initiatives are working with currently single crop farmers, especially for export markets vulnerable to trends such as with the cotton farmers in Mali, where adding a Bioenergy dimension adds resilience through diversity in markets. This diversification benefit is slightly less strong in Bioresidue or Bioresource cases which tend to be more fixed in terms of the available resources and markets. However income diversity for wood collectors (now gaining new revenue for their home garden trees) and an element of replanting for example, is crucial in spreading natural load and increasing security of supply to the end user in the Sri Lanka Spice Drying case for example.

## **5.6 Collaboration in the market chain is key at start up**

Another clear finding from the cases was the frequent instance of a coalition of enabling environment, market chain and/or supporting service actors being involved with the initiation of the chain. This is an important finding in terms of recognising the interrelationship of actors within a market system and the importance of their collaboration in the establishment of chains. Typically at least two types of actor such as Public/private, NGO/Private or University/Co-op were seen to be required to start initiatives and in general support early from local and/or national level government appeared to be crucial.

In developing rural chains supplying energy services there appears to be an especially important requirement for collaboration between supply and demand sides. For example if a product such as cooking ethanol is to be produced there must be suitable and appealing stoves available. Equally if stoves are to be available then cooking ethanol must be available at a suitably attractive price to avoid a chicken and egg scenario. In the cases selected it is clear that significant collaboration between fuel supply and appliance supply

is necessary in initiating market chains, although this can open out more as awareness rises, markets become more established and volumes increase.

Another notable form of collaboration which emerged in several case studies was where larger Bioenergy processors and smaller producers were linked in what appear to be mutually beneficial relationships. This has apparently been an effective strategy for both in initiating the new chains for example in Tanzanian Palm Oil and Guatemala Biofuels cases. This is reported to enable the larger firms to provide economies of scale in processing, investment in key physical capital, training and improved quality processes while securing a cost effective and reliable raw material supply. This model is attractive to outgrowers and producers as a stable additional revenue opportunity is created under agreements negotiated between the larger processors and sometimes newly established co-operatives and producer associations.

This relationship can enable connection with wider markets bringing money into the community from outside, as well as attracting donor/government support to what is a more social-enterprise approach. It is the emphasis on benefit sharing via shared-bargaining by producers, provision of local energy access benefits and regulation/oversight on the larger processors which differentiates the approach described in the cases from what in other situations could be an exploitative relationship.

## **5.7 Long Local Market Chains spread benefits**

It is notable in cases where initiatives develop market chains with greater numbers of processes, linkages and by-products, each responding to a demand then they are increasing the resource efficiency of the whole system, and at the same time spreading livelihoods benefits more widely within rural communities. Both direct and indirect benefits are noted in jobs at producer, processor, appliance and distribution levels within market chains as well as in the supporting services required by the chains. In addition to the benefits in terms of local revenue creation important benefits also noted in cases include development of virtuous circles of collaboration, trust and social capital. These are developed through formal and informal relationships established between different types of actor such as government, private firms, NGOs and producers, as well as between different participants in similar groups such as in the creation or reinforcement of a co-operative or producer association. These gains in trust and social capital visible in the Small-Scale initiatives are crucial for collaboration in other initiatives, to reduce transaction costs and to avoid “market blocking” behaviours.

Within these market chains it is important to differentiate between livelihoods benefits in a more complex way than simply counting number of jobs created, and several cases bring out challenges in this in terms of the difficulty of associated jobs which will need to be relieved if the initiatives are to spread. These issues are usually related to the access to

production or processing technologies needed to increase time and work efficiency, increase margins and thereby attract more producers into the sector. Efficiency on the supply side includes in production practices which balance job creation with productivity and effort level. If the work is too hard and margins are not high enough, it will not be sustainable and an increased level of mechanisation to a viable level may be required.

## **5.8 Moving Bioenergy resources up the energy ladder adds value**

In general an energy end use is an extremely reliable demand and the only instance in which a consumer will switch is if another source higher up the energy ladder becomes available at a price point within reach, and is considered as good value in terms of utility for the extra money. The energy ladder represents the continuum between the most basic wood energy burnt in a three stone fire at the bottom up to the most flexible, clean to use and convenient source of energy i.e. electricity, at the top. Barriers to switching to steps up the ladder, such as charcoal, gas (biogas or LPG) or liquid fuels, can involve capital costs of appliances as well as the costs of the fuel itself. In general one important feature of the cases selected is that there has been a focus on converting lower grade Bioenergy resources, residues and crops into energy vectors higher up the energy ladder such as charcoal, biogas, liquid fuels and electricity. This appears to be an important feature of the attractiveness and viability of Bioenergy initiatives as well as contributing to the health and labour saving (e.g. wood collection) benefits which are key to livelihoods improvements, particularly for women.

## **5.9 Any new activity raising demand raises prices, even for waste**

It is notable although perhaps unsurprising that in several cases the development of new economic activities around about a resource, even if that resource was previously a waste resource, implies an increase in price for that resource. This is particularly marked in Bioresidues cases such as the Peru Waste Oil-Recycling and the Senegal Chardust Briquettes examples where success of an initiative using waste leads to more competition for that waste. While from a user and natural resource perspective this is positive, from the perspective of the initiating institutions this is not.

Rising price features like this however are to be expected at national or local level where an increase in economic activity around a resource is occurring. If this increase is occurring, as in these cases, through more effective exploitation of resources this contributes to a positive overall trend as long as prices for the raw material do not rise to a point above the level of viability for the individuals and businesses involved. This should largely be regulated by the market itself but in some of the cases covered, some level of price controls or export restrictions have been a feature of initiatives.

## **5.10 Cases do not appear to show local staple food security to be affected**

The issue of rising prices due to new Bioenergy activities in rural areas affects the inputs and outputs from the Bioenergy market chains however in the Small-Scale Bioenergy initiatives covered, there appear to be only limited connections to food security, in terms of access and availability, which are particular to certain Bioenergy types and regions within the countries. This is largely due to the specific circumstances in the case regions where decisions have been made on a case by case, a crop by crop, region by region and even locale by locale basis which is the only way in which food security linkages to small-scale initiatives may be established. However there are some general preliminary conclusions which may be drawn as follows:

In all **Bioresources and Bioresidues** cases there is no discernible link between the initiatives and food production, prices or security. If a linkage is detectable it is to reduce the costs of cooking by providing lower cost cooking fuels and time-saving to households or increased revenues to restaurants through reuse of oil wastes.

The **Biofuels** cases fall into two main categories with respect to linkages with food production as follows:

- **Non-food cash-crop/intercropping**

In all the *Jatropha* cases a non-food crop is being used to produce the biofuel and all initiatives are promoting one or all of a series of measures to decouple this activity from food production including: Intercropping with food and/or using presently unfarmed land unsuitable for other crops. In cases such as the Mali *Jatropha* case, small producers are switching from a previous reliance on a non-food cash crop, namely cotton, to *Jatropha* production intercropped with food products. Residues from the processing of the *Jatropha* plants are used as fertilizer and the plants are selected for their low water requirements which limit competition for inputs to local food production. In the case of the Kenya plantations of *Acacia* trees as a biofuel, these are neither a food crop, nor do they use land otherwise normally used for food crops, however in the first 3 years of the cycle intercropping is done with short-season food crops which should add supply resiliency. Providing these approaches remain in place, for these cases an increase in food prices would only be expected to come from an increase in producer incomes rather than pressure on food production. Whether the approaches do remain in place will depend on the economic viability of the biofuel crops in what may not be prime conditions, and as such further more detailed economic and agricultural analysis as well as follow-up studies on the initiatives will be important to monitor this. Particularly in the case of *Jatropha*,

which is not currently fully developed as a “crop”, longer term yields in the cases must be tracked and probably improved.

- **Non-staple food crops as fuels**

In the cases of ethanol production from sugarcane in the Ethiopia Stoves and Brazil Micro-distilleries cases, the initiatives put an emphasis on the use of molasses, the waste residues from sugar processing as a main feedstock for ethanol production and in this case both projects would be Bioresidue projects and have no impact on sugar availability. However in these cases use of sugarcane for the ethanol is not ruled out but this is set in the context where both countries are large producers and exporters of sugarcane, and diversion of part of the ethanol output into local household fuels is not expected to have any impact on prices which are currently driven at international levels. In the Tanzania Palm Oil case, the entry of the initiative onto the local market is expected to have an impact on Palm Oil prices locally which are used in cooking. In response to this the initiative is proposing measures to limit outgrower purchases to only large Fresh Fruit Bunches (FFBs) to leave abundant small FFBs for local consumption, as well as promoting intercropping with food-crops in early years before the canopy prevents this. Again, the region has abundant natural and cultivated palm production and the market is currently linked to world market prices.

In Bioresources and Bioresidues cases therefore the Small-Scale Bioenergy initiatives covered do not have a discernable link with staple food prices and in the Biofuels cases an emphasis is given to non-food crops replacing non-food cash crops, intercropped with food or on uncultivated land, which exhibit limited or no apparent linkages to food prices. In cases where non-staple food crops such as Palm Oil or Sugarcane are used then a linkage is more likely to these complementary foods, although this is seen to be mitigated by specific supply and production circumstances in case localities where export crops locally in surplus are used in local energy applications.

## **5.11 Small-Scale Bioenergy initiatives can offer new choices in rural communities**

In all case studies a significant point is made about the potential of Small-Scale Bioenergy initiatives to bring *additional* Livelihoods opportunities to rural areas, and as such act to reinforce the viability of communities and so reduce pressures towards forced urbanisation of community members to find work. This is described as being delivered, amongst other mechanisms described in section 4.4, through a combination of increases in financial capital opportunities via job and productive activity creation, and increased social capital created through development of producer groups, co-operatives and rural market systems.

These gains are supported by, and in turn support, increases in human capital in rural areas through skills creation and improved energy service availability which has in turn been shown more generally to increase retention of more skilled and able individuals along with professionals such as teachers and health care practitioners. Creating viable choices for these individuals to stay in rural areas through a combination of improved revenue opportunities and living conditions within villages is an important contributor to rural development and the cases examined in this study offer optimism that appropriately implemented Small-Scale Bioenergy Initiatives can contribute to this outcome.

## 6 Recommendations for Further Work

The largely descriptive scope of this study and the preliminary nature of the conclusions point to the need for further work in more fully elaborating the challenges and opportunities of Bioenergy initiatives at the local level. While this report has sought to highlight linkages of initiatives to rural Livelihoods, which appear to be largely positive based on available information, there is no doubt that significant challenges and trade-offs remain to be explored in the development of Small-Scale Bioenergy initiatives if the Livelihoods benefits identified are to be realised on a widespread and sustainable basis.

Some of the areas recommended for further work to PISCES, FAO and other actors in the sector include:

- **Develop sustainability criteria for Small-Scale Bioenergy Initiatives**

Although substantial work is ongoing internationally on sustainability criteria for Large-Scale biofuels production for developed country markets as a liquid transport fuel, there has not been corresponding work undertaken for Small-Scale Bioenergy Initiatives. Such criteria might assist in improving the design and sustainability of future Bioenergy initiatives focusing on energy access and livelihoods at local levels. Furthermore it may offer an opportunity to develop some consensus on the role of Bioenergy more generally in a currently polarized global Bioenergy debate focused almost exclusively on Large-Scale production of transport Biofuels. The cases included in this report as well as some of the frameworks and approaches used could strongly contribute to such a process.

- **Develop more detailed economic analysis on a selection of cases**

The economics and competitiveness of Small-Scale Bioenergy Initiatives with other sources were not addressed in detail in the case studies although several key related issues emerged through the Markets and Livelihoods analysis including: oil price dominance, partial insulation requirements and strategies, business/management models, and pricing of wider benefits. More detailed economic analysis of a selection of cases, especially covering the four business model types noted in 4.3.2, would therefore be a valuable addition.

- **Develop Natural Resource efficiency and energy balance assessments for a selection of cases**

An assessment of the natural resource and energy inputs and outputs of different types of production, processing and appliance pathways for a selection of cases would provide useful additional information and verification of the efficiency of different Small-Scale Bioenergy approaches. This could support decision making for natural resource and

energy planning, however this analysis should be sensitive to local realities highlighted in the cases where efficiency can and must sometimes be secondary to accessibility and availability of local resources.

- **Work on incentives and constraints faced by farmers/rural people to adopt improved Bioenergy technologies and practices**

Some key outcomes of this study include the extent of the local market systems created and their resultant Livelihoods benefits, as well as the benefits of use of Bioenergy resources transformed to higher levels on the energy ladder as more convenient and cleaner fuels. More fully investigating the incentives and constraints for rural people in engaging with new Small-Scale Bioenergy technologies and practices as well as adopting improved Bioenergy products and services as consumers, would provide further insights into robustness of these outcomes and their potential replicability.

- **Develop understanding of the cases further from an Equity and Gender perspective**

The scope of the cases studies allowed for a focus on the livelihoods outcomes of initiatives primarily at a rural household level, however the impacts of initiatives on different individuals within communities and households can of course vary considerably. In particular an analysis of the Livelihoods impacts of the initiatives taking a gender perspective could add important additional further disaggregated information to that already developed for the cases. This could build on ongoing work under PISCES on the Equity elements of Bioenergy development as outlined in the recent report on Gender and Equity in Bioenergy in Kenya, available at [www.pisces.or.ke](http://www.pisces.or.ke).

- **Replicate and test case approaches in other applicable contexts**

The information provided in the case studies and in the summary report, although incomplete, will certainly provide ideas and insights on models, practices, technologies and approaches which may be replicated in other countries and contexts. Establishing such projects with action research elements would provide valuable feedback on replicability and applicability which could help verify case approaches. Such plans are already under development within the framework of the PISCES programme and contact from others interested in conducting similar work would be welcomed.

For any further information about specific cases or this summary report please contact [info@pisces.or.ke](mailto:info@pisces.or.ke) or the Case Study Project Manager Steven Hunt directly at [Steven.Hunt@practicalaction.org.uk](mailto:Steven.Hunt@practicalaction.org.uk)



## **7 Annexes**

### **7.1 Case Studies**

<b>Initiative Name</b>	<b>Case 1 – Mali Jatropha Electrification</b> <i>Small-scale Jatropha plantation for Rural Electrification of Garalo Commune</i>
<b>Location</b>	<i>Garalo Commune, capital of Garalo, Mali, West Africa</i>
<b>Initiation Date and Duration</b>	<i>1 August 2006 (36 months)</i>
<b>Funder(s)</b>	<i>AMADER, MFC, FACT Foundation (Fuels from Agriculture for Communal Technology), Stichting het Groene Woudt (SHGW)</i>
<b>Project Initiator</b>	<i>Mali Folkecenter (MFC)</i>
<b>Overall Budget</b>	<i>\$756,000</i>
<b>Output</b>	<i>300 kW (3 units 100 kW) Electrical</i>
<b>Area of Land</b>	<i>Potential of 10.000 ha out of which over 600 ha currently cultivated</i>
<b>Beneficiaries</b>	<i>More than 300 farmers (326), 247 electricity subscribers currently With a potential for more than 10,000 inhabitants including social services and income generation activities</i>

## Background and Context

Mali is among the poorest countries in the world, and characterised by uneven income distribution. The country is facing a huge energy bill due to rises in world oil prices while at the same time, the main export of the country, cotton, is hindered by subsidies allocated by Northern countries, particularly the USA, to their own cotton farmers. The macro situation is impacting on poor communities who are facing increased energy costs and decreased income due to low cotton prices. A large number of farmers have given up cotton production and, as a result, have no more or very little cash income from agricultural activities.

In Mali, 99 % of the rural population lacks modern energy services such as electricity and LPG. It is becoming increasingly clear that improvement of living conditions of the rural population cannot be based only on service provision from the state and para-statal budget and initiatives. The Garalo project is aimed at addressing these challenges at a community level. If proved successful the pilots will be scaled up given the huge land potential. The population of the commune (administrative sub-division made up of several villages) where the pilot is taking place is approximately 19,800 inhabitants and is composed of different ethnic communities.

The energy component of the Garalo project has been largely funded by a grant from AMADER- a para-statal company in charge of rural electrification- and an international non-governmental organisation, the FACT foundation. When the project was initiated, there was little information on the use of biofuel and its impact on

engines. There was also a lack of knowledge about engines designed to work only with pure vegetable oil. Despite these constraints the Garalo project gave priority to biofuel development and more specifically to Jatropha, chiefly because this is a model in which village natural resources (land and Jatropha) are processed and used locally, contributing thus to energy security and increasing the added value for local communities.

A series of other key reasons explain the choice of Jatropha development for electricity generation. Mali is the most experienced West African country in this field. With the support of GTZ, Mali carried out several pilot projects during the beginning of the 90s including equipment testing. However world oil prices were relatively low, as a result the cost effectiveness was a key factor in phasing out the energy component of the Jatropha programme. The dramatic increase of oil prices, particularly after 2005, and the biofuels investment world wide by large companies were instrumental in the re-development of Jatropha programmes in Mali which received a strong political support from the government. There are also other factors such as the environmental impact (possibility to use the residues as an organic fertiliser, soil protection, contribution to reducing greenhouse gas emissions etc.), economic impact (less inputs required e.g. fertiliser, water compared with other crops) and the low impact on food security. The inter-cropping model (Jatropha in association with crops for food) which is being largely used contributes to limiting the negative impact on food security.

## The Initiative Market Map

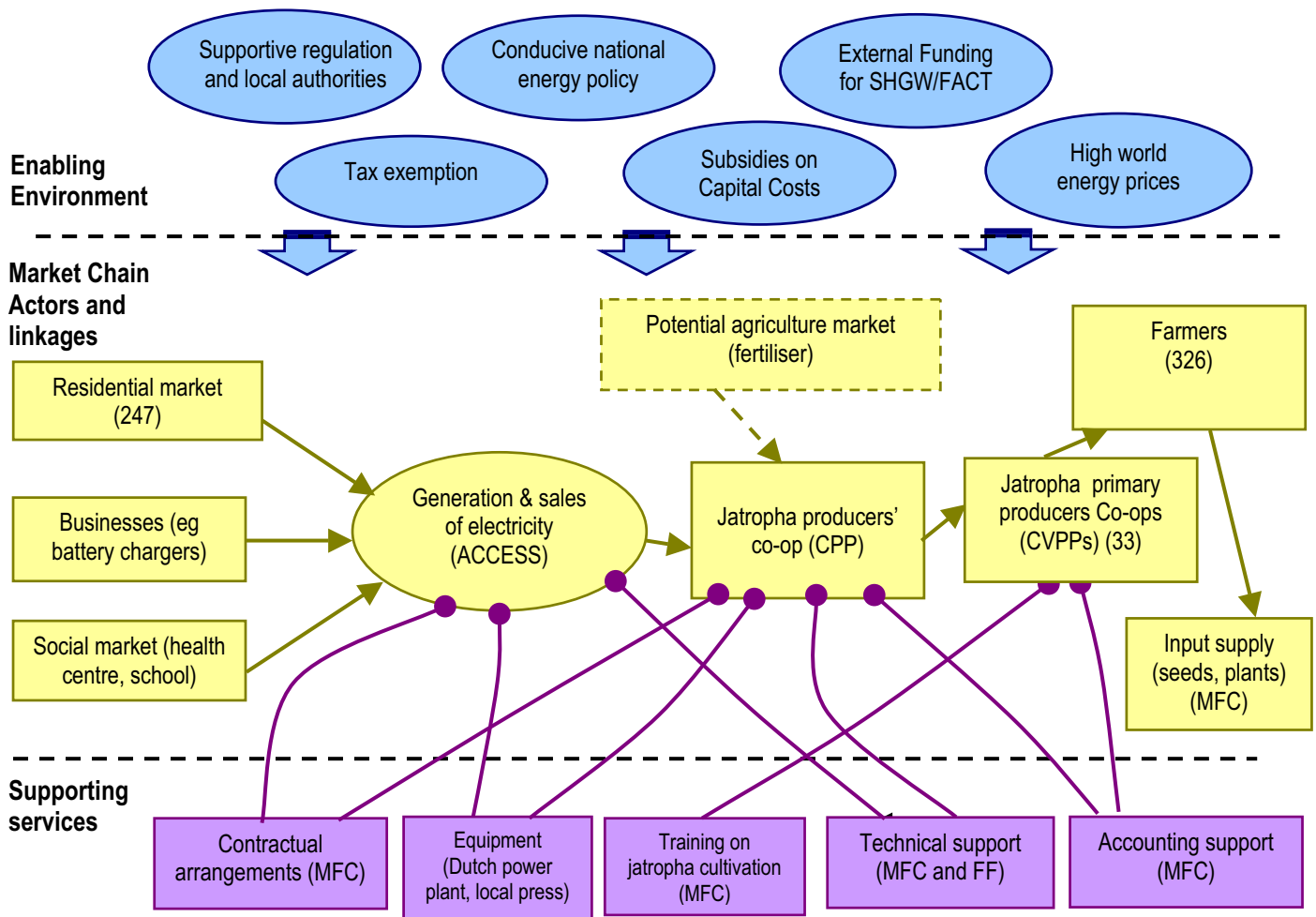

With respect to the **Enabling Environment**, the national energy policy strongly supports development of Jatropha for energy end uses. Local Authorities are playing an important role particularly thanks to their power to enact municipal by-laws.

The Jatropha supply chain is being developed by two main institutions: The Garalo Jatropha Producers' Co-operative (CPP) and the power company ACCESS. Jatropha farmers are at the heart of the business model supplying biofuel to the hybrid power plant. The CPP deals at the level of the “commune” with all issues regarding Jatropha seeds, production and sale of pure vegetable oil as well the residues (oil cake) as a fertilizer. In order to operate efficiently in all the villages, farmers, with the support of Local Authorities, have set up Jatropha producers village committees (CVPP) to deal with the key activities at the village level for instance seeds collection and transport to the co-operative. Out of a forecast of 10,000 ha of Jatropha, 600 ha, involving 326 rural families are already under cultivation. Many plantations are on land previously allocated to cotton. Farmers have opted for the inter-cropping production mode to ensure food security at

least at the village level. The residues of Jatropha seed processing can be used as a fertilizer. It is also envisaged to make an energy use of the oil cake to produce biogas.

The private power company ACCESS is responsible for generation and electricity sales. ACCESS has a capacity of 300 kW with a distribution network of approximately 13 km with the prospect for an extension of 3 additional kilometres. Currently 247 households are connected to the micro grid after a payment of \$30 as a contribution to the connection costs. As for electricity consumption, there are two broad tariffs categories. Subscribers with 50, 150 and 300 W are paying a monthly lump sum for their electricity consumption which is respectively \$5, \$12 and \$24. In addition there is a modest monthly contribution for street lighting which is 0.07 cents, 0.16 cents and 0.30 cents according to the power. Other subscribers with higher power and theoretically higher purchasing power, are billed according to their metered consumption at a tariff of 38 cents/kWh. In addition, they have also to pay fixed charges and higher contribution to street lighting (see appendix). It is worth

mentioning that the first 100 kWh are exempted from the VAT payment. The tariff structure is largely due to AMADER which is providing a large grant (approximately \$379,750) and is concerned by the power plant sustainability. Despite these relatively high prices, the recovery of the bills is over 90 % which demonstrates the willingness to pay for modern energy services. Customers who do not settle their bill on time were offered the option to delay the payment till their financial situation improves. Currently ACCESS has been able to recover almost 100 % of the recurrent costs.

In terms of **Supporting Services**, apart from its coordination and mediation function, Mali Folkecenter (MFC) has been supporting the Jatropha committees by setting up nurseries and distributing Jatropha plants through the village committees (CVPP), training etc. This is a crucial technical and financial input to the farmers. For the follow-up and evaluation, FACT foundation is providing its services to MFC. Other supporting services include the hybrid power plant equipment provided by a Dutch company and the locally manufactured press.

## Relationships between the actors in the Market Map

	Small-scale Farmers	ACCESS	AMADER	FACT	SGHW	MFC	CVPP	Co-op (CPP)
Small-scale Farmers:								
ACCESS	Fair - commercial, informal							
AMADER	None	Good - Financial, formal						
FACT	None	None	None					
SGHW	None	None	None	None				
MFC	Good - Technical, informal	Good - Subsidiary, formal	Good - Financial	Good - Financial, technical, formal	Good - Financial (subsidy)/formal			
CVPP	Good - formal : information	None	None	None	None	Good - informal, information		
Producers' co-op (CPP)	Good - commercial, formal	Good - commercial, formal	None	None	None	Good, financial formal		

To encourage ownership of the Jatropha production system by the rural communities, the social and business model was developed with strong involvement of the local authorities. For instance given the competition regarding Jatropha seeds, local authorities have prohibited their sales outside the commune to secure a sustainable supply for the hybrid power plant. Currently the supply at national level is very low compared with demand. A by-law was passed to ensure that local production is entirely devoted to the power plant. Jatropha production village committees were set up in 33 villages including 30 in the commune of Garalo and the three others are in another commune (Sibirila) close to Garalo. A co-operative of producers (CPP) encompassing all the villages has been set up for the purchase, commercialisation and processing of the Jatropha seeds by a co-operative owned press. The

co-operative is also responsible for the distribution to its members of the revenues generated by these activities on average twice a year. The agreed current price is currently 9.8 cents per kg which should allow both a reasonable margin for the farmers and a competitive selling price of Jatropha oil. The seeds will be processed by the co-operative and sold to ACCESS. There is not yet an agreed price as oil production is marginal given the time it takes between plantation and seeds production. ACCESS, the power company, is a MFC subsidiary with a commercial status, thus management and procedures (accounting, VAT, etc) are completely different from MFC which has NGO status. MFC and Fact Foundation are providing technical support to the power plant operator ACCESS and to the Jatropha producers' co-operative.

## Balance of Rights, Responsibilities and Revenues of Actors

	Rights	Responsibilities	Revenues
Small farmers	<ul style="list-style-type: none"> <li>- Use of land for farming or usufructuary rights in some cases</li> <li>- Sales of Jatropha seeds</li> </ul>	<ul style="list-style-type: none"> <li>- "Caretakers" of the land</li> <li>- Plantation, Jatropha seeds collection and delivery to the co-operative</li> </ul>	<ul style="list-style-type: none"> <li>- Cash from selling Jatropha seeds to CPP</li> <li>- Income from other farm products generated from intercropping system (Peanut, Fonio, etc.)</li> </ul>
Jatropha production village committees (CVPP)	<ul style="list-style-type: none"> <li>- Collect seeds at village level and deliver to the co-operative (CPP)</li> </ul>	<ul style="list-style-type: none"> <li>- Seeds collection storage and delivery to the co-operative in Garalo.</li> </ul>	<ul style="list-style-type: none"> <li>- Income from selling seeds to the Pressing co-operative (CPP)</li> </ul>
Co-operative of Jatropha producers (CPP)	<ul style="list-style-type: none"> <li>- Buy the seeds from the farmers (CVPP)</li> </ul>	<ul style="list-style-type: none"> <li>- Press the seeds and sell the oil to the power company (ACCESS)</li> </ul>	<ul style="list-style-type: none"> <li>- Income from Jatropha oil and potential income from seed cake selling</li> </ul>
AMADER (Rural electrification agency)	<ul style="list-style-type: none"> <li>- Promotion of Rural electrification in Mali</li> </ul>	<ul style="list-style-type: none"> <li>- Ensuring that subsidy is used according to regulation</li> </ul>	<ul style="list-style-type: none"> <li>- Grant from World Bank, other donors and State</li> </ul>
ACCESS (Power company)	<ul style="list-style-type: none"> <li>- Electricity sales</li> </ul>	<ul style="list-style-type: none"> <li>- Electricity production and distribution</li> </ul>	<ul style="list-style-type: none"> <li>- AMADER's subsidy</li> <li>- Electricity sales</li> </ul>
Electricity consumer association (ECA)	<ul style="list-style-type: none"> <li>- Interact with ACCESS and local authorities</li> </ul>	<ul style="list-style-type: none"> <li>- Look after electricity subscribers</li> </ul>	<ul style="list-style-type: none"> <li>- None</li> </ul>
MFC	<ul style="list-style-type: none"> <li>- None</li> </ul>	<ul style="list-style-type: none"> <li>- Project follow-up and quality control</li> </ul>	<ul style="list-style-type: none"> <li>- Grants, project implementation</li> </ul>

The whole model is based on the land ownership of small-scale farmers and the availability and status of the land. Even if the quantities cultivated remain modest, the Jatropha plantation growth rate is fast both at national level and in this commune. This is mainly due to the prospects raised by some large foreign companies, as well private entrepreneurs, to buy and process the seeds to produce biofuels either for the local market and/or for exports. As a result, there is a significant demand from many farmers to plant Jatropha, collect and process seeds for energy purposes. The main socio-cultural constraint is the status of the farmers and the land. Some have only the right to cultivate (usufructuary or tenants for life) either collectively or individually but they are not fully-fledged owners. As long as the usufructuary only grows non perennial short rotation plantations, the possible conflict between owners and usufructuaries is low because the investment is made on a short-term period. However, the plantation of trees is an investment over several decades. In Mali, according to customary law, it is considered that land planted with trees definitively belongs to the person or community who planted the trees. This explains the opposition of landowners to authorize migrants to plant trees including Jatropha as they may lose their landlord status.

The co-operative (CPP) is responsible for all the technical, commercial and financial issues in the supply

chain from the raw material (Jatropha seeds) to processing to obtain biofuel. Currently, co-operative members are benefiting from guaranteed although fixed prices for seed production. In a region with little opportunities for cash generation, this is an important economic and social safety net. In the unlikely event of a sharp fall of oil prices and diesel oil, the farmers might encounter some difficulties to sell their seeds. On the other hand, an increase of oil prices may give some margin for the co-operative to negotiate higher prices with the power plant's owner.

The other key issue regarding rights is related to independent power producers, such as ACCESS, which now have the right to produce, transport and sell electricity. In order to limit the monopolistic situation of ACCESS, an Electricity Consumer Association (ECA) was set up to look after the rights of the consumers and acts as an interface between the consumers and ACCESS. Although ECA does not have a legal status, it is recognised, de facto, by local authorities and attends the meetings to discuss the tariffs alongside with the key stakeholders, particularly local authorities, AMADER and ACCESS. It is AMADER's responsibility to ensure that the subsidies are being used efficiently and according to the procedures, including tariffs, by the recipients.

## Analysis of Livelihoods Outcomes

In terms of **human capital**, farmers have access to new knowledge regarding the *Jatropha* supply chain, including the technical aspects of production and commercialisation. Farmers have been trained on how to maintain and harvest their fields and they now have a fair understanding of the whole process from *Jatropha* growing to electricity services delivered to households, social services and income generating activities. In terms of job creation, this initiative has made it possible for a series of small businesses based on electricity such as repairs of electrical goods and tyres, shops, connection of houses, etc. to emerge.

With respect to **natural capital**, land use is the noticeable and important change. In the *Jatropha* supply chain, farmers have discovered alternative options to cotton plantations. To some extent this new opportunity increases the value of the land. Furthermore, irrigation is not necessary for *Jatropha* plantations. There is an initial water demand for the nurseries but the quantities are small.

In villages, **social capital** is an important asset. In Garalo, the whole supply chain is located within the village, which has contributed to strengthening social capital. Setting up a co-operative has allowed farmers to strengthen their relationships under a new formal status which increases their rights to get better income from their main asset (land). The Electricity Consumer Association is a powerful tool regarding the rights and obligations of consumers and also a vehicle to reinforce

social relationships. Access to modern energy services has also contributed to increasing social activities (music, dance etc) and security thanks to street lighting.

With regard to **physical capital**, this is one of the few integrated projects dealing with agriculture and energy infrastructure at this scale. As such, the project has made a substantial contribution to the physical capital of the village. Garalo, like more than 90% of the villages in Mali, was not electrified. As a result, social services were of poor quality and there was little prospect of new income generation activities. Electricity is rightly considered by all villagers as an entry point to modernity and a means for a better livelihood. An additional key infrastructure component is the mechanical press and the associated institutions and services to process *Jatropha* seeds.

Increasing **financial capital** is a key component of this initiative as it allows the generation of new cash flows to rural farmers which dried up with the cotton crisis. The farmers have now a secure local market and a guaranteed cash income. It has also been noted that new income-generating activities have developed related to electricity usage and a decrease in the selling prices of some basic products in rural areas has occurred. The other indirect financial impact is at the macro level where the substitution of diesel oil with renewable energy generated locally will reduce fossil fuels imports, although with the scale still small as yet, the impact at national level is negligible.

## Overall Conclusions

This is a fairly large-scale and complex pilot project and the substantial subsidy by AMADER was therefore crucial to its implementation. The hybrid power plant is designed to run on pure vegetable oil (PVO) and diesel. Successful trials were carried out to test *Jatropha* oil as a fuel to power the plant. It is envisaged that 5% of PVO will supply the plant in 2009 which will increase rapidly over the next years to reach almost 100% by 2013. So far only 326ha are being planted using intercropping out of a target of 10,000ha. However, electricity is already available to villagers and the key conditions (hybrid power plant installed, tariffs structure designed by key stakeholders, support from national and local authorities etc.) seem to be in place for almost total transition to *Jatropha* oil for electricity generation.

In order to reduce oil dependence and the huge deficit of its balance of trade, the national energy policy in Mali promotes renewables and particularly *Jatropha*. Such a policy has contributed to securing the subsidy for the

power plant. The involvement and commitment of local authorities was an important step towards increasing the economic impact of the project. The NGO MFC also played an important role from initial fundraising till the implementation of the power plant and follow-up work. The MFC leadership in this project and the consultation process with the stakeholders- particularly the farmers- may be considered a good practice model for other similar initiatives. A strategic decision initiated by MFC in consultation with the key stakeholders was that the development of *Jatropha* should improve the livelihood of the village population and increase the financial capacity of local communities, particularly the farmers. The *Jatropha* project was therefore conceived to provide cash income to the farmers given that cotton revenues had significantly decreased. The huge interest expressed by farmers who are not already part of the scheme and the national demand for *Jatropha* oil are good indicators for scaling-up the project.

<b>Initiative Name</b>	<b>Case 2 – Senegal Char dust Briquettes</b> <i>Charcoal Dust Collection and household fuel production in Saint Louis, Senegal</i>
<b>Location</b>	<i>Saint Louis City, Senegal, West Africa</i>
<b>Initiation Date and Duration</b>	<i>April 2007 - end December 2008 (current project). Support by PERACOD for second phase likely</i>
<b>Funder(s)</b>	<i>Senegal-Germany Co-operation Programme to promote rural electrification and household energy (PERACOD-GTZ- Ministry of Energy and Mines)</i>
<b>Project Initiator</b>	<i>PERACOD and BRADES (Bureau de Recherche Action pour le Développement Solidaire)</i>
<b>Overall Budget</b>	<i>US\$20,000</i>
<b>Output</b>	<i>Charcoal briquettes from charcoal dust for domestic cooking. Current average annual production 20,000 kg and rising</i>
<b>Key Mechanisms</b>	<i>Supply contracts to secure charcoal dust collection with charcoal retailers</i>
<b>Implementor</b>	<i>BRADES company : Bureau de Recherche / Action pour le Développement Solidaire</i>
<b>Beneficiaries</b>	<i>26 charcoal retailers/wholesalers, 14 char-briquettes retailers, Charcoal dust collectors, several thousands households in Saint-Louis</i>

## Background and Context

In Senegal, charcoal and wood consumption are important causes of deforestation. In Saint-Louis, North Senegal, as well as in other large cities, securing energy supply for cooking has become increasingly difficult. This is because the reduction of quotas for biomass energy production, and the diminution of forest areas devoted to it, along with the high cost of transport, high LPG prices and shortages, have coincided with reduced purchasing power of low income people due to rising inflation.

Among the 18,420 households of Saint-Louis, with a population of approximately 160,000 inhabitants (Regional Service of National Forestry Commission of Saint-Louis, 2005), the majority use charcoal as a main fuel with an average daily consumption of two to three kilograms per household. Decades ago the department of forests banned charcoal exploitation in 'at risk' forest areas, which increased the incentive to develop alternative energies. This measure was accompanied with important subsidies allocated to LPG that benefited those on middle and high incomes.

However, an increase in world oil prices has constrained Senegal to gradually phase out the subsidy. The charcoal supply in Saint-Louis is marked by a strong seasonal variation between the dry season (November to April) and the wet season (May to October), caused by difficulties of carbonisation during this latter period.

Only the areas of Kolda and Tambacounda, hundreds of kilometres from Saint-Louis city, are authorised to produce charcoal, resulting in increased transportation cost and reduced supply, Saint-Louis has experienced increasing selling prices for charcoal (€0.31/kg in Saint-Louis in 2006 against €0.38/kg in 2007).

This situation offers improved prospects for the penetration and scaling up of local renewable alternative solutions, such as recycling low-value charcoal dust. There is a significant potential resource of charcoal residues in the many existing charcoal yards and storage areas in Saint-Louis. This new fuel could replace approximately 28% of the annual charcoal consumption in the city (PERACOD data).

To expand the range of available cooking fuels, a Public Private Partnership (PPP) was established between the PERACOD programme, the BRADES private Company (Bureau de Recherche/Action pour le Développement Solidaire) and CFF (Co-opérative Forestière du Fleuve). The objective of this partnership is to process bio-residues available in the 'charcoal stockyards' of Saint-Louis into charcoal briquettes (known as char-briquettes). After a feasibility study carried out in 2006 on the potential of charcoal dust, PERACOD supported BRADES Company to install a Production and Marketing unit of char-briquettes in the town of Saint-Louis in November 2007 through the public private partnership (PPP).

## The Initiative Market Map

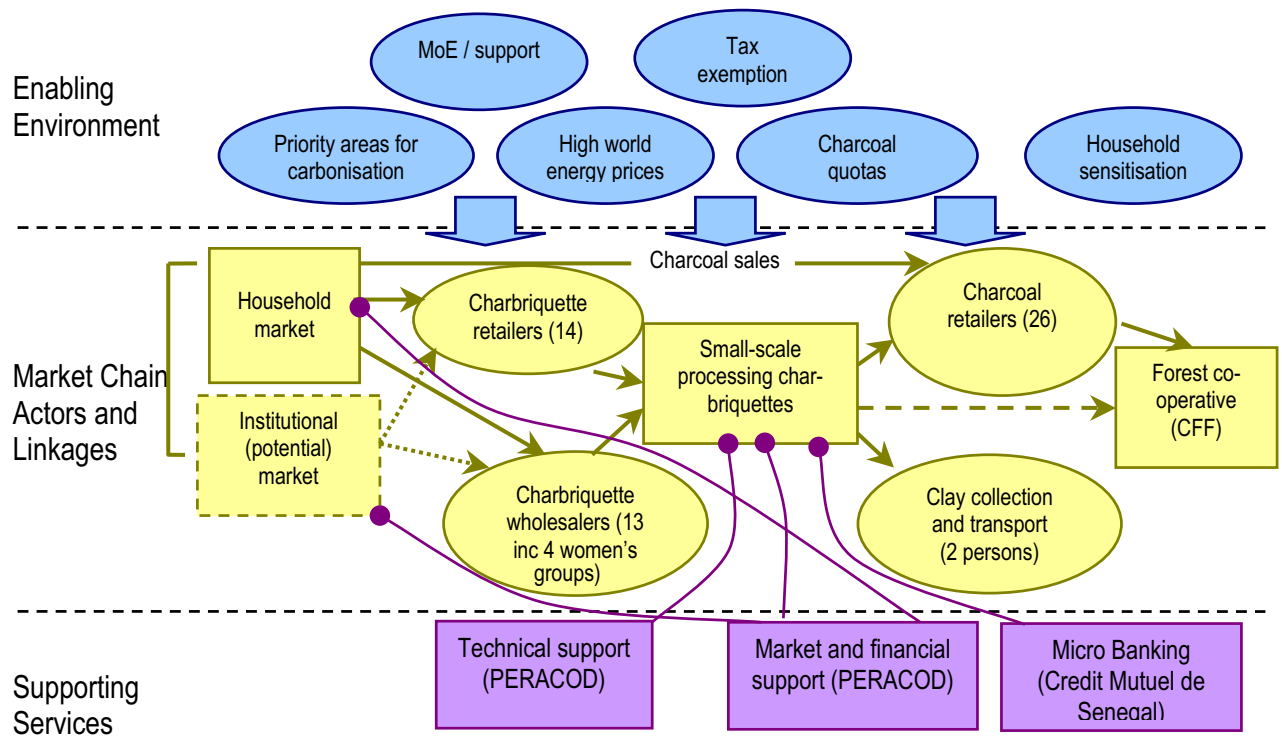

With respect to the **Enabling Environment**, Senegal is a country benefiting from a favourable political and institutional environment regarding the development and implementation of new initiatives aimed at forest protection and greenhouse gas mitigations. Private sector and the civil society (mainly NGOs) usually have good working relationships with central authorities (the Ministry of Energy in this case). PERACOD is, in this case, a partnership between the Ministry of Energy and GTZ.

PERACOD played a leading role in initiating and coordinating the process to involve key stakeholders in the project, in particular the micro-banking system, the Ministry of Energy and the company in charge of developing and managing the project. The department of water and forests have been supporting and following the initiative very closely. Such support gives added credibility to the exploitation and commercialisation of this new household fuel. Unlike other fuels, it is currently, de facto, exempted from taxes.

The **market chain actors** shows the flow of revenues from the final consumers (currently limited to households in Saint-Louis city) via the processors of the raw material suppliers, to the forest co-operatives. In this case the raw materials comprise charcoal dust

and clay, used as a binder. However there is also an emerging institutional market, particularly restaurants that are shown with a dashed line. It is worth mentioning that charcoal retailers who are supplying char dust as a raw material to BRADES are also selling charcoal to households and businesses as their main source of income.

With respect to the **Supporting Services**, the funding by the private micro-banking sector (Crédit Mutuel du Sénégal - CMS) as well as PERACOD and regulation incentives provided by the Ministry of Environment were instrumental in starting up the business, run by the family-owned private company BRADES which benefitted from two sources of funding:

- The PERACOD programme: 15,267€ (10.000.000FCFA) (Reinforcement of production capacity and equipment purchase).
- Mutual credit of Senegal (Crédit Mutuel du Senegal CMS): 3053€ (2.000.000FCFA) (furniture and technical equipment purchase and availability of working capital).

▪ BRADES must pay back monthly instalments to CMS over a two-year period from November 2007.



## Relationships between actors in the Market Map

	MoE (Department for Water and Forests)	BRADES	PERACOD	CMS	Forest co-operatives (CFF)	Char Briquette Retailers/ Wholesalers	Charcoal Retailers
MoE (Department for Water and Forests)							
BRADES	Good - Institutional, informal						
PERACOD	Good - Institutional, formal	Good - Technical, financial, formal					
CMS	None	Fair - Financial, formal	Fair - Informal/ formal				
Forest co-operatives (CFF)	Fair - Regulation (quotas), formal	Good - information, formal	None	None			
Char Briquette Retailers / Wholesalers	None	Good - commercial, Formal	Fair - Information, informal	None	None		
Charcoal retailers	None	Good - Financial, formal	Fair - Information, informal	None	Fair - commercial, formal	None	

The char-briquetting process was initiated by PERACOD who signed a partnership agreement with BRADES providing the latter with funding for at least 50% of the costs. This agreement was for a total of 947€, equally split between the two partners and designated for equipment (briquetting, drying, tools etc.). In the agreement, BRADES was committed to provide the premises, install the equipment, and commercialise the final product. In addition, BRADES was to serve as an experimental platform for PERACOD, and share all technical and financial information. This agreement led to the commencement of activities and ensured that the partner had the necessary technical and managerial skills to develop the new business.

The second agreement was in the framework of a Public Private Partnership (PPP), in which PERACOD provided additional funding. BRADES benefited also from a loan from the Mutual Credit Bank of Senegal. The relationships between the forest co-operative (CFF), BRADES and PERACOD were mainly about

identifying which charcoal retailers would be supplying the charcoal dust.

The supply of charcoal residues is currently secured through procurement agreements with charcoal retailers. In total 26 contracts were signed over an 8 month period. Two people directly employed by BRADES provide the supply of clay. This is also the case for char-briquette retailers and wholesalers (women's groupings and individuals) who are directly employed by BRADES.

The forest co-operative (CFF) helped in identifying which charcoal retailers would supply the charcoal dust. In Senegal, charcoal is a highly regulated business in which charcoal co-operatives are important stakeholders. In the case of Saint-Louis, charcoal retailers are supplied by the forest co-operative. BRADES is currently considering the possibility of getting its charcoal dust supply directly from the co-operative. Such an option may reduce the costs of collection and, as a result, reduce the price of charcoal dust.

## Balance of Rights, Responsibilities and Revenues of Market Actors

	Rights	Responsibilities	Revenues
Ministry of Energy/ Department of Water and Forests	Regulation framework & Fiscal policy (tax exemption in this case), charcoal quotas allocation. Quotas allocation for charcoal making	Ensure that exemption is efficient and properly used.	State budget Taxation on biomass supply chain
BRADES	Collection, and processing of charcoal residues; contract loans	Char-briquette production and commercialisation, loan reimbursement	Income from char-briquette sales
PERACOD	Initiation of charcoal residues project	Follow-up of BRADES charcoal residues project	Grant from Germany and Senegal

Mutual credit of Senegal (CMS)	Credit provider	Monitor credit	Profit margin on credit
Forest river co-operative (CFF)	Wood exploitation and charcoal making	Market supply at reasonable price	Income from charcoal and potential for charcoal residues
Women groupings/retailers (GIE)	Buy char-briquettes	Sale of Charcoal Briquettes	Income for char-briquettes sales
Charcoal retailers	Business with charcoal and residues	Buy and sell charcoal and residues	Income for charcoal and chardust sales

With respect to **rights**, the Ministry of Energy and Mines is empowered to develop an incentive regulation framework to reach its policy objectives. For instance, quota allocation for charcoal making is the **responsibility** of the Ministry of the Environment. It is the responsibility of the Ministry of Energy to ensure the adequate supply of the market. As a public institution, the revenues of the Ministry of Energy come from the state budget. Wood energy taxation including fines (wood cutting permits, charcoal making, transport) is another source of direct income for the Department of Water and Forests.

Within the biomass supply chain, forest co-operatives have the right to produce charcoal through quotas allocated by the forest administration. However due to the lack of control, production often exceeds the quotas, contributing to deforestation. This may explain, in some instances, the situations leading to conflicts that have arisen between the forest administration and the professional and non-professional actors (e.g. illegal charcoal makers). The forest co-operative revenues are mainly derived from the sale of charcoal to wholesalers, and to a lesser extent to households, small businesses and institutions.

BRADES, retailers (women's groups) and wholesalers are the key beneficiaries of this initiative. As a registered company, it has the right to produce and commercialise char-briquettes. Currently BRADES' main revenues are derived from this commercialisation.

PERACOD and the Ministry of Energy played a key role in marketing the product, particularly its acceptability and affordability (through tax exemption) by the households in Saint-Louis city.

Potential conflicts between charcoal retailers and char-briquettes manufacturers are not excluded although the

risk is marginal given the size of charcoal demand. Other potential conflicts of interest might involve blacksmiths who are currently buying small amounts of chardust for their businesses. However, even though we assume a substantial increase in chardust prices, the impact will be low, given the fact that chardust accounts for a small percentage of their running costs.

Regarding the **revenues**, the purchase cost of good quality residues (larger diameters) varies from 6 cents to 9 cents/kg according to the sites and the relationship between supply and demand, which makes an average of approximately 8 cents/kg, plus transport costs. Clay is collected near the premises at the backwater of Khor. The cost of its extraction and transport is approximately 1.5 cents/kg and this is carried out by two people with an average wage of 3.8€ per day.

The final product is packaged using recycled paper before being put on sale. The cost of packaging is roughly two cents per bag and 3.25 cents after accounting for labour costs. Two women are daily employed especially for this task, producing on average 20 bags /person /hr. The company sells char-briquettes to 13 wholesalers, out of which four are women's groups, as well as to 14 retailers. The retail price is 19 cents/kg whereas the wholesale price is 15 cents/kg. This compares with a retail price of 30 to 38 cents/kg for normal charcoal sold in the town, depending on the season. Over a period of eight months (November 2007 to June 2008) about 18,000 kg were produced and approximately 15,000 kg commercialised. This gives a turnover of around € 2,850, based on retail prices that could be considered as significant in the context of Saint-Louis city, which is marked by a high level of unemployment.

## Analysis of Livelihoods Outcomes

Regarding **human capital**, the technology transfer of the rotor press has contributed to increased knowledge in the recycling of previously low-value residues. The involvement of vulnerable people in business activities

strengthens their livelihoods. The family company which was created (BRADES) operating in the biomass sector has become a reference for other entrepreneurs.

In developing countries **social capital** is an important asset that allows marginalised people to cope with a harsh economic environment. The establishment of a family company and the involvement and reinforcement of women's groups and retailers are instrumental in strengthening the social capital. The new professional relationships, and trust developed, contribute to strengthening social networks. For instance, women's groups are commercialising the char-briquettes.

With regard to **natural capital**, recycling low value energy residues is contributing to forest protection by decreasing the extraction rate from natural forests which are already under a great deal of pressure. Furthermore, BRADES is allocating 10% of its profits to reforestation programmes carried out in the lower reaches of the Senegal River valley. Charcoal dust recycling is certainly contributing to the cleanliness of the local environment, and impacting on the health of surrounding communities as well as retailers, thereby reducing by the household expenses devoted to health

## Overall Conclusions

At this stage, this pilot is very promising, with sales of 15,000kg between November '07 and June '08 with a significant monthly growth, (from less than 500kg in November '07, to 2,000kg in June '08). A crucial test in the coming years will be the extent to which the initiative scales up, and whether it continues to enhance the livelihoods of poor people, and the environment as it has done so far. The key lessons and conclusions that emerge are as follows.

The support of the local authorities (informal authorisation to collect and transport charcoal residues) as well PERACOD and micro financing (Mutual Credit of Senegal) were crucial in the development and sustainability of this initiative.

Although this is still a small business, the jobs generated (management, collection, processing, commercialisation) contribute a great deal to improving livelihoods, creating additional value and income opportunities from a previously unused resource.

Results of acceptability tests of charcoal briquettes carried out for households and businesses (restaurants, dyers etc) show that there is good acceptability and a potential market for these briquettes. This has been reflected in the growth of char-briquettes production. Improvements can be made regarding ash removal and, to a lesser extent, smoke emissions. This is an area which must be considered in scaling-up strategies.

BRADES is not yet a completely autonomous company because the market is not yet well established, and

care. However, further investigations are necessary to assess more thoroughly the environmental impact from a health perspective.

**Physical capital** comprises the basic infrastructure and goods needed to support livelihoods. A more sustainable supply of affordable energy services, thanks to the recycling of charcoal dust, is helping poor people to cope better with meeting their basic energy needs. Furthermore, the penetration of a new technology in this region (the rotor press) is a significant contribution to increasing the efficiency of the charcoal chain, contributing to poverty alleviation and reduction of environmental damage.

With respect to financial capital, there is an increase in income through job creation (8 regular workers currently and 16 in prospect); creation of income-generating activities for the char-briquettes retailers (14 employed in total) and increase in revenues for charcoal retailers.

there is still PERACOD's technical support, which is currently being phased out. Nevertheless, the development of a Public Private Partnership between BRADES and PERACOD is a sound step towards the technical and financial self-sufficiency of this company and the emergence of new similar companies.

Development of the market will certainly lead to a price increase of charcoal dust, which is the main raw material for the briquettes. Such an evolution needs to be anticipated by increasing productivity and by the utilisation of very low value wastes such as charcoal dust fines that are currently barely used. Indeed, currently only thick charcoal residues are being processed. Blacksmiths already use this category of residues, although given their volumes, there is not yet competition between the two market segments. The utilisation of very low value residues (fines) will increase the overall efficiency of the whole supply chain.

The involvement of the Ministry of Energy and PERACOD will remain, over the short term, crucial to promote this initiative, particularly the marketing component and access to financial capital for new investments. Experiences in other countries shows that substantial market gain for a product needs to be accompanied by a well-targeted marketing campaign that is often beyond the financial means of the producers. However once this has been achieved, cases have proved that business viability can continue long after the government support ends.

<b>Initiative Name</b>	<b>Case 3 – Senegal Typha Charcoal</b> <i>Transforming pest invasive species (Typha Australis) into marketable charcoal in Senegal</i>
<b>Location</b>	<i>Saint Louis Region, Senegal, West Africa</i>
<b>Initiation Date and Duration</b>	<i>2003 until end December 2008 (first phase). Support for second phase very likely.</i>
<b>Funder(s)</b>	<i>PERACOD: Programme to Promote Rural Electrification and Household Energy Supply</i>
<b>Project Initiator</b>	<i>PERACOD, PREDAS (Regional Programme to Promote Household and Alternative Energy in the Sahel ), Tiabakh rural community</i>
<b>Overall Budget</b>	<i>US\$1950</i>
<b>Output</b>	<i>Typha briquette: daily output of 1 carbonisation unit = 120 kg, recorded production from 18 May 08 to 23 June 08 = 1315.5 kg</i>
<b>Area of Land</b>	<i>Estimated green biomass potential 120 to 150 tonnes/ha GIS estimate for 40km = 7,000 ha and 3 million tonnes of green biomass</i>
<b>Beneficiaries</b>	<i>Young people producers' groupings of four people of Thiabakh rural community, approximately 200 women involved in promotion.</i>

## Background and Context

Wood and charcoal account for 60% of the energy supply of Senegal and nearly 85% of household energy consumption. In July 2002, PREDAS organised a workshop to share the results of the “Study on the Development of Typha for Energy Usage”. A key outcome of the workshop was the possibility to transform *Typha Australis*, a fast growing invasive river reed species, into briquettes for household cooking after agglomeration and carbonisation (agglombriquetting). Unless the plant is uprooted, the re growth rate is extremely high.

Throughout the delta and along the shallow stretches of the Senegal River, millions of tons of Typha biomass could be harvested every year. A 2003 satellite estimate over 40 km from the Diama dam on the Senegal river shows that there is a potential of 3 millions tons which can generate 519 000 tonnes of dry biomass. There is currently a sharp deficit in biomass supply in Saint Louis region which is supplied from Kolda and Tambacounda forests. These two zones are authorised to produce charcoal, however they are located respectively 785 km and 609 km away from St Louis city. As a result of the increased transportation cost and reduced supply, St Louis has been experiencing increasing selling prices of charcoal (€0.31/kg in 2006 increased to €0.38/kg in 2007).

In October 2003, following the very encouraging preliminary tests carried out in Mali on production and use of Typha briquettes, PERACOD decided to set up a pilot unit. In January 2005, a joint mission of PREDAS and PERACOD experts in Mali, confirmed the reliability of the technology as well as the quality of the final product.

Between the end of 2004 and the end of 2006, the Saint-Louis office developed a carbonisation “Pilot Unit” in Ross Béthio in the premises of SAED (Delta Management and Exploitation Company).

Tests were carried out based on the carbonisation technology known as “Three drums”, as well as a compacting process for briquette manufacturing known as “Press Rotor” technology. The results of the technical and acceptability tests among households, confirmed the relevance of the PERACOD strategy regarding the utilisation of low value biomass residues (Typha, rice husks, cotton stems, millet etc.) to produce quality household fuels.

The site of this initiative was selected on the basis of environmental, economic and social criteria, in particular: (i) the growth of Typha and its density must be of sufficient quantity to ensure the cost-effectiveness

of the business, (ii) the site must be close to a city to facilitate the Typha marketing and commercialisation (lower transport costs). On this basis, the project was set up in the village of Thiabakh, 12 km away from the Richard Toll commune (administrative division). Access

to Richard Toll is facilitated by tracks maintained by the Sugar Company of Senegal which operates in this area. Due to the absence of housing, the producer's grouping installed their own premises using Typha which is also a good building material.

## The Initiative Market Map

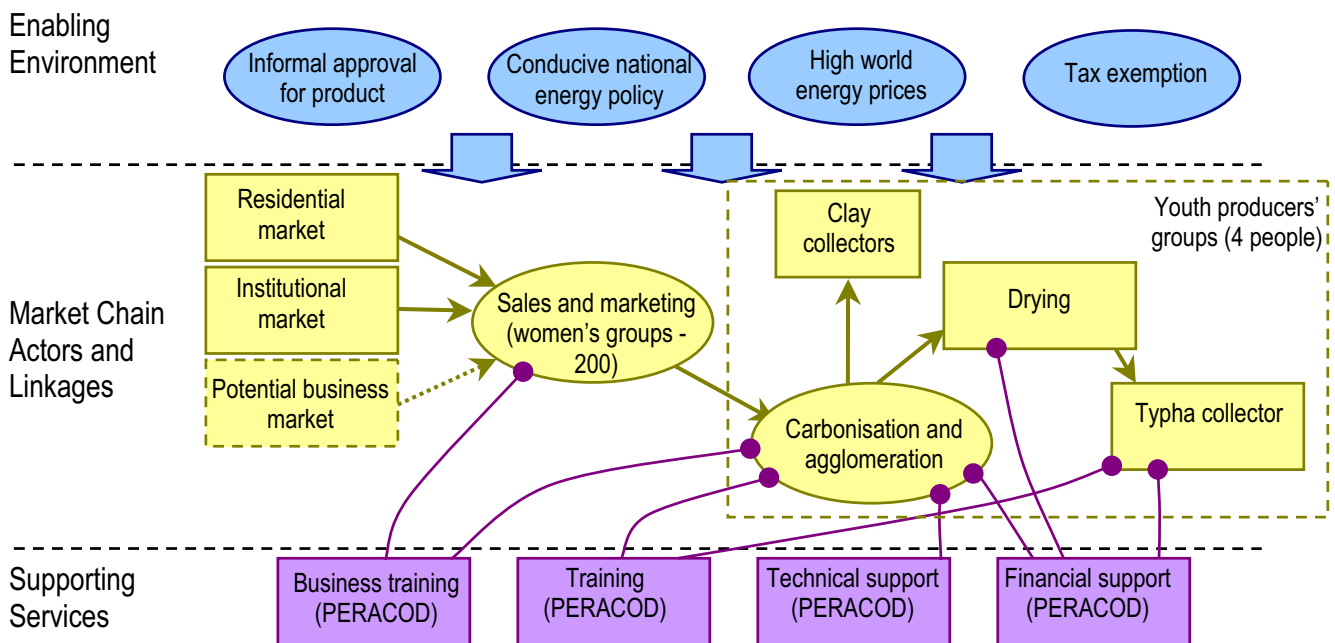

With respect to the **Enabling Environment**, Senegal benefits from a favourable political and institutional environment regarding the development and implementation of new initiatives aimed at forest protection and greenhouse gas mitigations. For instance, Senegal was one of the first African countries to set up an Agency to deal with rural electrification and prioritise renewable energy. Local authorities have welcomed the Typha australis initiative and actively participated in the product launch. Furthermore, the president of the rural "commune" (administrative division) and the village representative (customary authority) have legally approved the business developed by the producers' grouping of Tiabakh rural community.

With respect to the **Market Chain Actors**, the producer's grouping on one hand and commercialisation by women's groups on the other hand are the two key players. The producers' grouping is formed by four young people from the Tiabakh rural community. The grouping is in charge of the whole process from Typha collection, drying, and processing

using the rotor press technology to obtain the final product.

Typha is manually harvested using sickles. On average the yield is 250kg/person/hour which is approximately 1500 kg of fresh Typha per day based on 6 hours per day. Harvesting is a very demanding job. This is the reason for which from a situation where initially there were three local producers' groupings, there is only one still currently involved. Currently the company in charge of the management of the delta (SAED) has contracted a large company (Fougerolles) to clear the irrigation canals. The possibility of using this Typha was considered by the project. However it appeared that this option would not be worthwhile, as the Typha would have been uprooted and accompanied with mud which makes the operation complex and more time consuming than current practice. In Mali, where a similar project is being carried out, mechanisation is being considered (harvesters' boat); however the investment is high. Such an option could be introduced for production on a much larger scale.

Because it is cheaper to transport the final product to the consumer rather than the unprocessed Typha, the agglobriquetting unit has been installed near the site. On average, it takes 5 to 10 days to dry the Typha. The daily production of a plant equipped with 4 carbonisation kilns and 2 agglomeration units (rotor press technology) is 120 kg of briquettes allowing the creation of 4 jobs for a total investment of approximately US\$1300 including small equipment (tools etc.) and the drying area. Commercialisation is carried out through a women's grouping. About 200

women are involved in selling and/or promoting the Typha charcoal.

The project benefited from subsidised **Supporting Services**. PERACOD provided 90% of the total investment and the youth grouping the remaining 10%. Two types of trainings were provided. The business training over a 4-day period was provided by a financial institution FEPRODES. PERACOD provided the technical training involving all the steps of the production chain (collection, drying, processing).

## Relationships between Market Actors

	Youth producers' grouping	Women's groupings	PERACOD	Local authorities	Ministry of Energy
Youth producers' grouping					
Women's grouping	Good – commercial, formal				
PERACOD	Good - financial, technical, formal	Good – information, informal			
Local authorities	Good – legal, formal	None	Good - Informal		
Ministry of Energy	Good – information, informal	None	Good - information, informal	Good -information /informal	

The producers' grouping is the key player and as such it is at the centre of all the relationships. Local authorities and the representative of the village have formally recognised the producers' grouping and its activity which provides all the facilities to operate in this area.

To ensure efficient marketing and commercialisation of the product, a protocol was set up between the producer's grouping of Thiabakh rural community and the women grouping Federation of Thiabakh which involves 625 women. Such a large number of women provide a good basis for the sales. In West Africa women are in charge of cooking and also buying or collecting household fuels. Depending on the season, two to three women are in charge of this activity however the profits benefit the whole federation of women.

The relationships between PERACOD and the producer's grouping are regulated by contractual

arrangements such as partnership protocols. According to the protocol, the equipment and the final product (Typha briquette) belong to the producers as long as they comply with the terms of the agreement. Initially, protocols were signed with three groupings based around Richard Toll which is the main town. The partnership between PERACOD and the producers' grouping is primarily focused on the technical (e.g. training) logistic as well financial and institutional support (investment subsidy, relationships with local authorities and Ministry of Energy etc.). For instance, there is no regulation regarding the development of *Typha Australis*. PERACOD has been providing its support for a better visibility of the producers and to facilitate their activities within the area. As an example, the National Forestry Commission inspection of Saint Louis is informed of all the activities carried out by the producers' grouping and is closely following the project.

## Balance of Rights, Responsibilities and Revenues of Market Actors

	Rights	Responsibilities	Revenues
Youth producers' grouping	- Typha harvesting (informal right)	- Production of Typha briquettes - Compliance with protocols	- Cash from selling Typha briquettes
Womens' marketing groupings	- None	- Commercialisation of Typha briquettes	- Income from selling Typha briquettes
PERACOD	- To promote household energy alternatives	- Follow up of protocol with producers and project monitoring	- Grant from Germany and Senegal
Local authorities	- Enact by laws, recognition of the producer's groupings	- None	- State budget
Ministry of Energy	- Regulation framework	- Adequate supply of the energy market	- State budget

The business is based on harvesting and processing *Typha australis* which is currently a free natural resource. In terms of **Rights** the youth producers' grouping of Tiabakh community are benefiting from their informal right to collect and transform this resource. Given its huge potential and its nuisance, it is very likely that it will remain free for the coming years, if not decades. This assumption means that despite the hardship, there seem to be good prospects to make a livelihood out of this business.

Local authorities have many rights in their geographical zone particularly with the decentralisation laws which have given more power to local authorities. Local authorities have legally endorsed this project by a formal recognition of the producers' grouping.

In terms of **Responsibilities**, it is the responsibility of the grouping to supply an alternative household product and that of the women's groupings to deal with commercialisation.

Regarding the **Revenues**, given the constraints during the wet season (difficulties drying Typha and briquettes), the optimal production period is limited to 8 months. Over this period, 23 tonnes of Typha

briquettes can be produced which gives an annual turnover of approximately US\$4,500 based on selling price of 19.4 cents/kg. Recent records show that over a 3 month period (23 March to 23 June 2008) 2,300 kg were sold at a selling price of 19.4 cents/kg which gives a total income of US\$544 which may provide a reasonable profit given the fact that the main raw material is completely free of charge. However detailed calculations are needed to work out more precisely the profit margin generated by this business.

Typha charcoal is sold by the producers to the women's groupings at 19.4 cents/kg and the selling price to the final consumers is 24.3 cents/kg. Two to three women are fully involved in commercialisation and 200 women in promoting the charcoal Typha. Compared with char-briquettes, the wholesale and retail prices are the same in order to avoid any market distortions. Assuming the whole production is commercialised by women's groupings, according to the production records between 23<sup>rd</sup> March and 23<sup>rd</sup> June 2008, the sales were 2800 kg which gives a maximum profit of US\$140. Given the potential market, the profit may increase dramatically in the near future. Furthermore this income for women grouping is quite important as it is re-invested into social and income generating activities.

## Analysis of Livelihoods Outcomes

As for the **human capital**, producer's groupings are having access to new knowledge regarding the Typha supply chain. This includes harvesting the natural resource, carbonisation and briquetting. Furthermore training was provided on management and business issues. This business is very labour intensive particularly for Typha harvesting. In the case of successful scaling-up, there are therefore real prospects for the creation of a large number of jobs even when harvesting is mechanised

**Physical capital** comprises the basic infrastructure and producer goods needed to support livelihoods. With regard to households, they have other household fuels alternative to meet their basic energy needs from a renewable local energy source. Furthermore, the processing equipment put in place by the project forms the physical tools required to turn the Typha resource into a marketable product likely to improve the livelihood of poor people.

At this stage, **financial capital** gains are limited given the fact that the project is still at an early stage. However, given the huge potential in the area and also in two neighbouring countries (Mali and Mauritania), there are good prospects to generate important local revenues from this business, all the more that the initial investment for small-scale units is low (about 1,000 euros).

## Analysis of Livelihoods Outcomes

In terms of **human capital**, producer's groupings are having access to new knowledge regarding the Typha supply chain. This includes harvesting the natural resource, carbonisation and briquetting. Furthermore training was provided on management and business issues. The business is very labour intensive particularly for Typha harvesting. In the case of successful scaling-up, there are therefore real prospects for the creation of a large number of jobs even when harvesting is mechanised

**Physical capital** comprises the basic infrastructure and producer goods needed to support livelihoods. With regard to households, they gain a household fuel alternative to meet their basic energy needs from a renewable local energy source. Furthermore, the processing equipment put in place by the project forms the physical tools required to turn the Typha resource into a marketable product likely to improve the livelihood of poor people.

The **social capital in West Africa** is an important asset which allows marginalized people to cope with harsh economic environment. This is also the case in this region of North Senegal. The project has allowed young people to develop social network not only within their village but also with the important federation of women's groupings as well as local authorities.

**Natural capital** is the most important component of this project with a serious impact on the livelihood of poor people. Indeed Typha Australis is an invading plant of the family of the reeds, which colonizes the flooding zones of the Senegal and Niger rivers with serious consequences on the human activities and the ecosystem (fishing, access to water, health, and irrigation). The widespread prevalence of Typha has become a threat to the environment, obstructing animals' access to water, encouraging the proliferation of weaverbirds, and increasing the incidence of bilharzias and malaria in the population. It is estimated that Typha constitutes a potential threat for about 100.000 hectares of cultures irrigated land in the delta and the low valley of the Senegal river. However this plant is also an opportunity to develop on a large scale a new local household fuel which will contribute a great deal to reducing the pressure on natural forests which are currently supplying the bulk of household fuels in Senegal. It is worth mentioning that similar projects are being developed in Mali, whereas Mauritania is exploring the feasibility of a pilot project.

At this stage, **financial capital** gains are limited given the fact that the project is still at an early stage. However, given the huge potential in the area and also in two neighbouring countries (Mali and Mauritania), there are good prospects to generate important local revenues from this business, all the more that the initial investment for small-scale units is low (about 1,000€).

The **social capital** in West Africa is an important asset which allows marginalised people to cope with harsh economic environment. This is also the case in this region of North Senegal. The project has allowed young people to develop social networks not only within their village but also with the important federation of women's groupings, as well as local authorities.

**Natural capital** is the most important component of this project with a serious impact on the livelihood of poor people. Indeed Typha Australis is an invading plant of



the family of the reeds, which colonizes the flooding zones of the Senegal and Niger rivers with serious consequences on the human activities and the ecosystem (fishing, access to water, health, irrigation). The widespread prevalence of Typha has become a threat to the environment, obstructing animals' access to water, encouraging the proliferation of weaverbirds, and increasing the incidence of bilharzias and malaria in the population. It is estimated that Typha constitutes

a potential threat for about 100.000 hectares of irrigated land in the delta and the low valley of the Senegal river. However this plant is also an opportunity to develop on a large scale a new local household fuel which will contribute a great deal to reducing the pressure on natural forests which are currently supplying the bulk of household fuels in Senegal. It is worth mentioning that similar projects are being developed in Mali, while Mauritania is exploring the feasibility of a pilot project.

## Overall Conclusions

Five main conclusions can be drawn from this pilot project implemented in St Louis, Senegal, and also in Mali.

- Local natural resources are an important asset and can be tapped on a large scale. In most villages where adequate training is provided, human resources are available and the impact of capacity building contributes to improving directly or indirectly the livelihoods of poor people
- Local authorities and ministries in charge have supported the initiatives on the basis of the economic and environmental potential offered. This support has been instrumental in enabling the initiative to take root.
- Very often lack of technical knowledge and financial capital are major constraints. The lack of financial capital is associated with reluctance to take risks. Indeed for poor people, financial assets are very limited and the conventional banking system is not tailored to deal with their needs. Access to financial capital through traditional mechanisms is often very expensive and not adapted to productive investments. Government or aid support can unlock this barrier if properly targeted and supported by training and other types of stimulus and support.
- External initial support, particularly regarding project feasibility, coordination, mobilisation of initial capital and capacity building seems to be necessary to promote new initiatives.
- The sustainability of this project and its scaling up remain an important challenge. There is indeed a large natural potential. Precisely because of the size of the potential and the hardship to manually harvest sufficient quantities to reach an economically viable quantity, other technologies options do need to be explored.

<b>Initiative Name</b>	<b>Case 4 – Tanzania Sisal Biogas</b> <i>Katani Ltd SISO Project and Cleaner Integral Utilisation of Sisal Waste for Biogas and Biofertiliser</i>
<b>Location</b>	- SISO Project located on all 5 estates owned by Katani, all within 150km of Tanga City, Tanga Region, - Cleaner Integral Utilisation of Sisal Waste for Biogas and Bio-Fertiliser located at Hale Estate.
<b>Initiation Date and Duration</b>	- SISO Project initiated 1999, 9 years duration - Cleaner Integral Utilisation of Sisal Waste for Biogas and Biofertiliser subsequently initiated 2005, 4 years duration
<b>Funder(s)</b>	- SISO Project: Katani Ltd (Private Company), no external funding. - Cleaner Integral Utilisation of Sisal Waste for Biogas and Biofertiliser: CFC, UNIDO, Tanzanian Government, Katani Ltd.
<b>Project Initiator</b>	- Both projects initiated by Katani Ltd and Tanzania Sisal Board.
<b>Overall Budget (if available)</b>	- SISO Project: Predominantly financed by Katani Ltd and farmers - Cleaner Integral Utilisation of Sisal Waste for Biogas \$1,503,312
<b>Output</b>	Production of sisal, with sisal waste used to power the biogas plant at Hale, which has an output of 150kW. The biogas plant is to be replicated on all estates, to produce 6MW of electricity.
<b>Area of Land</b>	By end of 2007, 4500 ha planted with sisal with total land allocation of 12000 ha.
<b>Beneficiaries</b>	- SISO Project: 2000 Families – Income and electricity through local grids Though not yet beneficiaries it is intended that local communities, outside the SISO scheme, will benefit from the provision of low cost access to energy in the future.

## Background and Context

Lying on the Coast of Tanzania, bordering Kenya, Tanga Region has a population of around 1.7million, with a growth rate in population from 1998-2002 of 1.8% and a population density of 60 persons per square kilometre. The population of Tanga Region has been increasing since 1957, and as a result of high population density, forests have become endangered and wood scarce. The increasing need for income and food is not matched by increased economic development or food production.

Sisal is the most important cash crop, used to produce yarns, ropes, carpets, clothing and composites, and sold to the domestic and international markets. Since 1999 Katani Ltd, a sisal growing company, has developed a system of smallholder and out-grower sisal farming, on land owned by the company and in the surrounding areas. Katani has developed the first biogas plant in the world to convert sisal biomass to biogas. This is used to run electricity generators which power production machinery, with excess electricity supplied to out-growers/smallholders homes, schools and hospitals.

Organic fertiliser is produced as a by-product, process heat is used for drying fibre and could be used to dry paper made from sisal pulp. Using current production

methods, only 4% of the actual plant is recovered as fibre. The residue was either burnt, producing carbon dioxide, or rotted naturally, producing methane. The use of sisal waste for bio-energy is thus environmentally beneficial. Converting the waste to biogas increases the profit to farmers, since 80% of the plant mass is suitable for biogas production.

Investment for a biogas project came from The Common Fund for Commodities (UN Body) US\$ 927,712; UNIDO US\$ 225,600; and the Tanzanian Government US\$ 350,000, during phase one of the pilot plant. Ongoing financing is received from government and external agencies. The project is managed by UNIDO and a 16-member coordinating committee with representation from the FAO, CFC, UNIDO, TSB, Katani Limited, the Sisal Association of Tanzania (SAT) and relevant government ministries. The biogas project is profitable and Katani Ltd plans to provide local access to low cost bioenergy via a system of mini grids from their biogas plants. Funds are being sought to undertake the work and plans are under development.

Planting and harvesting takes place all year so there is no element of seasonality to earnings. The farmers are paid monthly, and they are guaranteed a market for

their product. There is little vulnerability to environmental shocks since sisal is so drought resistant and sisal provides an income even if food crops fail, thereby increasing financial security.

The planned Phase 2 of the biogas project involves a scale up from 150kW to 300kW, requiring US\$ 472,026 in funds. Phase 3, in 2009, involves developing biogas for vehicles and piping fuel to households, which will

cost US\$ 100,000. Nine other commercial-scale plants will be established at the other nine factories owned by the company, each with the capacity to produce 1 MW of electricity. This will give Katani an overall output of 10 Megawatts of electricity with a similar amount of process heat.

### The Initiative Market Map

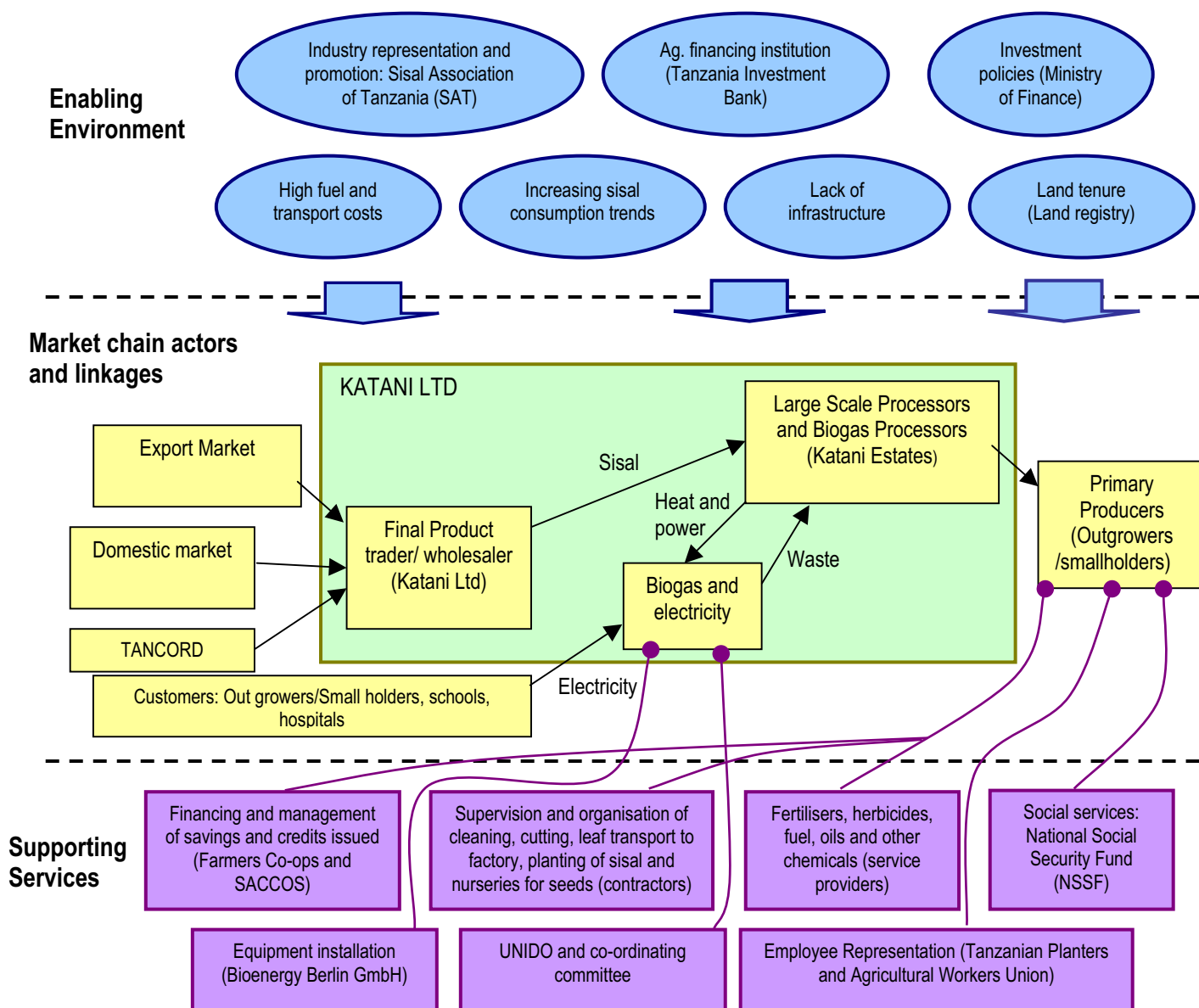

With respect to the **enabling environment**, an increase in consumption of fibre locally and in regional markets is critical to the success of the programme. Land taxes, taxes on labour, and taxes on production need to be reduced to encourage farmers to expand

their holdings. Investment funds for investment in agriculture in Tanzania are still hard to access; only firms with foreign connections have been able to get all the financing they require, and that from overseas. Farmers on their own cannot afford to venture into

adopting new technologies. Transport costs locally are very high due to fuel costs. At present a financing window for agriculture has been opened at the

Tanzania Investment Bank. Regarding gender, Katani provides women with the chance to engage in economic activities.

## Relationships between Market Actors.

	Katani Ltd	Out growers/ Small holders	Farmers Co-ops and SACCOS	TSB	TANCORD	SAT	NSSF	TPAWU	UNIDO & CFC
Katani Ltd									
Out growers/ Small holders	<b>Good</b> , formal, Technical, Service & Financial								
Farmers Co-ops and SACCOS	<b>Good</b> , formal, negotiating relationship	<b>Good</b> , formal, power building & supportive							
Tanzania Sisal Board (TSB)	<b>Good</b> , Formal, Regulatory, advisory, supportive & representative	None	<b>Good</b> , Formal, Regulatory, advisory, supportive & representative						
TANCORD	<b>Good</b> , Formal, Financial & Market	None							
Sisal Association of Tanzania (SAT)	<b>Good</b> , Formal, Representative & Promotional	None	None						
National Social Security Fund(NSSF)	<b>Good</b> , Formal	<b>Good</b> , Formal, Financial & Service	<b>Good</b> , Formal, Financial & Service	None	None	None			
Tanzanian Planters and Agricultural Workers Union	<b>Good</b> , Formal & Regulatory	<b>Good</b> , Informal, Supportive & Service	<b>Good</b> , Informal, Supportive & Service	None	None	None	None		
UNIDO and Coordinating Committee	<b>Good</b> , Formal, Financial, Support & Knowledge Sharing	None	None	None	None	None	None	None	

Katani Ltd assists the farmers in forming registered community-based operations and accessing loans, and grants to pay for services; and facilitates the repayment of loans to financiers. In 2006 Katani Ltd mobilised US\$ 1.2 million in loans for farmers and is presently negotiating a further US\$3.3 million. The firm has set up the Mkonge Umoja Savings and Credit Co-operative Society with a capital of around US\$ 500,000. Katani are assisting farmers in strengthening community based organisations so that they provide the full range of production and delivery of services. To date there have been no breakdowns in stakeholder relationships and no apparent barriers to progress.

Training programmes and study tours to biogas production facilities in China were organised to enable staff at Katani to gain valuable experience in the operation and maintenance of medium-scale biogas energy systems. The biogas is produced with the waste derived from the Sisal decortication plant. The stored biogas is used to run two 150kW electricity generators for a rated total electricity output of 300 kW, with an intended output of 500kW by the end of 2009. The electricity is used mainly within the decortication plant and some of the excess is supplied to the domestic quarters within the estate. The excess biogas can also be distributed to surrounding communities to cover cooking and lighting requirements.

## Balance of Rights, Responsibilities and Revenues of Market Actors

Actors'3Rs'	Rights	Responsibilities	Revenues
Katani Ltd (including Estate Management, Mkonge Energy Systems Ltd and Central Workshop Ltd)	- Guaranteed purchase of all sisal grown by small holders & out-growers.	- Out-grower / small holder extension services and training - Running electricity generators which power production machinery, - Providing excess electricity generated from biogas to homes, schools and hospitals. - Management of sisal operation, from growing through to marketing and sales - Strengthening CBOs to provide services	- Income from selling Sisal and potential income from sale of bioenergy to the national grid in the future. - Savings through use of biogas instead of bought fuel. - 6 MW of electricity will make substantial fuel savings once installed
Out-growers/ Small holders	- Use of land for sisal production. - Guaranteed revenue from sale of sisal leaves to Katani.	- Production of sisal meeting quality control standards. - Maintenance of the land - Planting of sisal crop Adherence to terms of land lease.	- Income from sale of sisal leaves - Income from sale of food grown alongside sisal
Farmers Co-Operatives	Negotiating a fair price for farmers	- Representing interests of small holders/out growers. - Management of savings and credits issued, and financing of farmer operations.	
Tanzanian Sisal Board (TSB)	Regulation/development of sisal industry	Regulation, development and Promotion	
TANCORD		Purchase of sisal fibre from estates Production of various sisal goods	Income from sisal products
Sisal Association of Tanzania	Operate under act of parliament	Representation and promotion of mutual intercessions with government	
National Social Security Fund (NSSF)	Operate under act of parliament	Provision of social services	
Tanzanian Planters & Agr. Workers Union		Out-grower/smallholder and employee representation	
UNIDO and the Common Fund for Commodities	Promotion of sustainable development via industrial development	- Managed the Project on Product and Market Development for Sisal and Henequen Products through the Project Coordinating Committee - Management and Coordination of Cleaner Integral Utilisation of Sisal Waste for Biogas and Biofertiliser project. Provision of investment, knowledge and support	- International donor countries

Out-growers and smallholders sub-lease land from Katani, upon which they produce sisal under contract for sale to Katani Ltd. Katani Ltd provide a guaranteed market for the sisal, providing income throughout the year. Food security is assured through intercropping and continued growth of food on traditional land in the village, reducing the likelihood of any food versus fuel conflict. Both out growers and Katani Ltd are linked to the Sisal Value Chain which includes the international market; they are therefore at risk from changes in international markets and finance. Katani has overall responsibility for production and sale of sisal.

Katani Estates pay primary producers US\$ 370 per tonne of fibre while they get US\$ 850 per tonne covering processing costs and Katani Limited gets US\$ 85 per tonne. The revenues continue throughout the year. Katani buys farm inputs and sells the sisal through well established marketing channels worldwide. Katani receives the revenue from these sales. All other providers of services for Katani are under contractual arrangements and receive income for work carried out. The Sisal Association of Tanzania, NSSF and TSB are bodies established by Acts of Parliament.

## Analysis of Livelihoods Outcomes

**Human Capital:** There has been an 80% increase in the number of children attending school and access to health care has improved. Katani provides energy for schools and hospitals, improving access to education, communications and healthcare.

The introduction of the sisal programme typically gives rise to increased yields for crops grown alongside it, e.g. an increase in maize yields when grown alongside sisal from 400 kg per hectare, the average for Tanga Region prior to the programme, to 1,200 kg per hectare after the programme was noted in a UNIDO and CFC report (2006).

Access to biogas reduces health problems associated with the use of wood for cooking.

**Physical Capital:** Out growers and smallholders are building better houses and buying bicycles, mobile phones and better clothes. They can access electricity and cleaner drinking water. Electricity is used to provide lighting for work in non-daylight hours, and to run small scale industries, which can subsequently increase incomes.

**Financial Capital:** The SISO project has led directly to the creation of rural employment for both men and women, with increased levels of income resulting from sisal production, related increased output of food per hectare and related reduced food production costs. Higher standards of living alongside increased levels of employment have reduced the rates of migration from rural to urban areas.

**Natural Capital:** The use of sisal waste for bioenergy is an environmentally beneficial procedure, reducing methane emissions from waste which would previously have been left to rot and CO<sup>2</sup> emissions from waste burned in the field. Carbon dioxide emissions have gone down as fossil fuel burning is reduced. The biogas process yields biological fertiliser which when applied to the fields reduces the need for chemical fertiliser. Access to biogas/electricity for cooking heat for smallholders/out-growers reduces the pressure on forest resources.

**Social Capital:** The formation of farmers groups and co-operatives by smallholders and out-growers has increased social capital. Greater household income and access to communications may extend the scope for participation in external activities

## Overall conclusions

It is felt that the Siso scheme has maximised its potential to support local livelihoods. Farmers are now forming Savings and Co-operative Societies to be able to raise capital for financing their operations. It is difficult to assess the impact of the Cleaner Integral Utilisation of Sisal Waste for Biogas and Biofertiliser since only phase one has been completed. It appears however, that, by following the Katani model, there is significant potential, to produce large quantities of bioenergy in a socially and environmentally sustainable fashion in order to reduce poverty.

Key factors affecting the sustainability of the SISO project include rising costs of electricity, labour, fuel and oils, cost of building materials and of foodstuffs which small holders/out growers do not grow. By using the by-products of sisal production to generate energy, the industry will make itself more competitive in the global market.

Key factors affecting the sustainability of the Biogas project include the availability of financing and cost of labour and building materials.

Providing access to low cost energy is hampered by the monopoly of Tanzania Electrical Supply Company, and related costs of transmission lines and transformers, although recent Energy and Water Utilities Regulatory Authority (EWURA) legislation on small power projects favours renewable energy suppliers. The high cost of tanks (80% of investment cost) and a lack of infrastructure to enable biomethane to be used for vehicles and households also act as barriers to the success of the biogas project.

Crucial success factors for both projects are that the production of sisal and biogas from sisal waste following this model are both environmentally and socially sustainable. As an emerging market, the opportunities for investment and development in sisal are significant. Research shows that there is huge market potential, of the order of millions of tonnes worldwide, for sisal. The sisal industry has witnessed an upward trend, with national production in Tanzania up 84.5% from 20,000 tons in 1997 to 36,900 in 2007, and momentum is continuing to gather..

<b>Initiative Name</b>	<b>Case 5 – Tanzania Palm Oil</b> <i>FELISA ('Farming for Energy for better Livelihoods in Southern Africa' / 'Kilimo cha Nishati') Company Ltd.</i>
<b>Location</b>	<i>Kigoma, Kigoma Region, Tanzania</i>
<b>Initiation Date and Duration</b>	<i>Incorporated: April 2005 Start of field operations: November 2005</i>
<b>Funder(s)</b>	<i>Private company</i>
<b>Project Initiator</b>	<i>Hamimu Hongo (Tanzanian) and Stefan De Keyser (Belgian)</i>
<b>Overall Budget</b>	<i>US\$ 836,000</i>
<b>Output</b>	<i>Crude palm oil (CPO); Biodiesel</i>
<b>Area of Land</b>	<i>100 hectares planted 4,250 hectares now owned for expansion</i>
<b>Beneficiaries</b>	<i>FELISA has yet to begin large-scale production of CPO or biodiesel. 990 farmers have received seedlings, and a large number of individuals who currently farm palm oil trees are potential suppliers to FELISA and therefore—along with their households and the employees of the company—are beneficiaries as suppliers of an emerging market.</i>

## Background and Context

FELISA Ltd is based in Kigoma town on the shores of Lake Tanganyika in western Tanzania. The company cultivates oil palm trees (*Elaeis guineensis*) and processes fresh fruit bunches (FFB) to produce crude palm oil (CPO), an edible oil used for cooking, cosmetics and pharmaceuticals. FELISA is presently 100% self-financing, funded by equity contributions from 24 (majority Belgian) shareholders.

FELISA has a 100 hectare oil palm plantation 75km from Kigoma town. They have recently obtained another 4,258 hectares of land 150km from Kigoma, where they plan to also plant oil palm. A first crop of seedlings was planted in December 2005, and a second in January 2007. Oil palm trees take four to five years to mature to fruition, and the production of CPO is planned to begin in 2009. FELISA also aims to purchase FFB from local small-scale farmers as part of a proposed outgrower scheme. They calculate that a total of 500 hectares under local cultivation will meet demand once their own plantations bear fruit.

An influx of refugees from conflicts in Burundi and the Democratic Republic of Congo has placed great pressure in the Kigoma area, but this trend is now reducing with repatriations. The refugee camps absorbed many natural resources regionally, as evidenced in mass deforestation for firewood and a large reduction of water. Investment in western

Tanzania, especially Kigoma region, is low, and there is sparse allocation of funds in the agricultural sector. Many people in the region are subsistence farmers and, according to FELISA, do not notice economic shocks as profoundly as those with stronger ties to the wider economy.

Crops are harvested and planted during the rainy seasons of October-January and March-June, and prices decline during these times of peak production. During off-peak periods farmers owning palm oil harvest the few ripe FFB and prune and weed. Between January-February farmers harvest maize and plant fast crops, such as beans and sunflower. The planting of palm oil trees takes place at the onset of the rainy season because the oil palm requires much water. Although malaria is present all year, infection rates increase during these wet periods.

The company's initial strategic choice was to grow and process palm oil for biodiesel production for the domestic market, targeting the national utility TANESCO back-up generators and possible transport fuel blending markets. However with the world market price of CPO having risen sharply, from \$0.25/litre in 2005 (when their first planting took place) to a high of US\$1.35) in 2008, FELISA are considering additional non-energy market options.

## The Initiative Market Map

The market map below is currently in an emerging state and FELISA are still considering which market segments to target. The map illustrates the various

existing market options that FELISA will be joining and developing further.

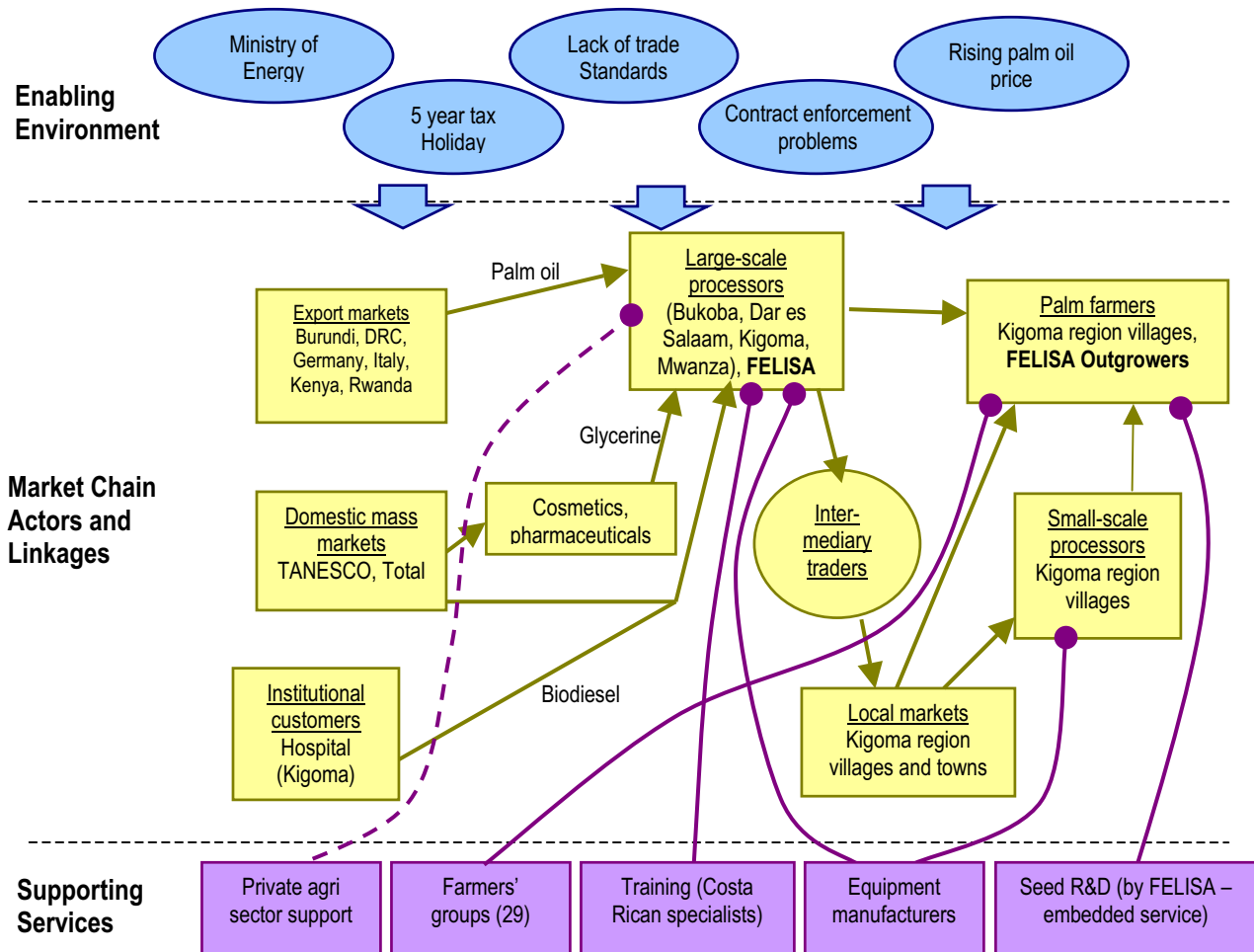

With respect to the **Enabling Environment**, FELISA have sought to influence the Ministry of Energy's biofuel policy so that they and other domestic biodiesel producers can operate in a known environment when negotiating with foreign buyers. One call is for a policy that stipulates the blending ratio between biodiesel and fossil diesel used in Tanzania. Ideally this policy would also ensure that a certain percentage of biodiesel is produced internally. Primary producers and processors have not made similar efforts to engage with the policymaking process. Contract enforcement issues have not affected any Kigoma-based actors, nor have bodies that monitor trade standards. There are reported cases of product adulteration, with incidents of waste water being added to CPO (apparently by middlemen who, in one case, paid farmers to bring waste water to be added to the oil). The effect has been that some

buyers avoid Kigoma and now purchase instead in Mbeya. While FELISA has not experienced corruption, employees recognise that any process that involves government officials can run the risk of delay due to institutional bureaucracy which may impact on the timely accessing of services. In registering their new land, for example, FELISA had to wait close to an entire year for the process to be completed. This is due to the fact that only one person is authorised to make declarations about land and their services are in high demand. FELISA currently enjoys a five year tax holiday, along with a capital goods import duty exemption. Local farmers, however, are frequently levied to pay various taxes, including a tax for goods going to market. Accessing loans or grants for agricultural and agri-related industries is difficult. Banks in particular perceive the sector to be high-risk, and



rarely provide loans, especially for perennial crops. FELISA have recently applied to Private Agricultural Sector Support for assistance in obtaining a loan and, if successful, this should have positive knock-on effects for primary producers working with FELISA.

Of the **Supporting Services**, inputs and finance are sourced by FELISA themselves. All linkages are created and maintained by FELISA's own efforts, although they have benefited from some outside influences, in particular training received from specialists from Costa Rica. Research relating to market information is self-initiated, and lessons are

learnt within the company from their exposure to the domestic and international production markets. FELISA's proposed outgrower scheme, for example, bears some resemblance to the agreement between Prokon, a German private company in Rukwa that sources its *Jatropha* from local farmers in the region. The Ministry of Agriculture sends investors interested in palm oil production to FELISA, and one of the Directors is regularly invited to present at international conferences. FELISA regard themselves as a learning institution.

## Relationships between Market Actors

	Palm Farmers	FELISA	Small-scale Processors	Intermediary Traders	Farmers' Groups
Palm Farmers					
FELISA	Good, Formal, Technical, Commercial				
Small-scale Processors	Fair, Informal Commercial	Fair, Informal Competitive			
Intermediary Traders	Poor, Informal Commercial	Fair, Informal Competitive	Fair, Informal Commercial		
Farmers' Groups	Good, Formal Technical, Commercial	Fair, Informal, Technical, Commercial	Fair, Informal, Commercial	Poor, Informal, Commercial	

Before the emergence of FELISA relationships between market actors were purely commercial, with palm farmers existing in a state of dependency on a few buyers who dictated prices and offered no other support. In Simbo village, some 18km from Kigoma, for example, palm farmers have calculated that there are many risks in processing their crop themselves, and the profit margin from their few drums of oil is small. The disadvantage of allowing others to process their crop, however, is that the farmers do not retain ownership of by-products such as kernel cake which can also be sold.

FELISA wants to support palm farmers by offering technical support in farming methods through conducting extension services together with the government. A rural development policy exists, but it is not always implemented. FELISA's solution is to introduce an outgrower scheme based on demonstration plots where an extension officer will train small-scale suppliers on modern oil palm production and provide palm farmers with high yield hybrid seedlings. In the long run they hope to help palm farmers establish their own processing plants. The

intended result is to improve the quality of FFB that farmers bring to FELISA, thereby helping meet demand. Palm farmers are under no obligation to sell only to FELISA, and the price is negotiable; although there would be a contractual agreement that binds the farmer to supply a certain amount of a crop at a specified quality over a given period of time.

Farmers' groups share information on farming methods and markets. They provide an opportunity to FELISA, to engage with many farmers at once, and a channel for lobbying decision makers in favour of FELISA's planned actions. The largest group is *Wabango*, who have their own savings co-operative, and a leadership committee who have conducted a palm oil study tour in Malaysia. *Wabango* have expressed an interest in selling their oil directly to FELISA, but price negotiations are yet to be finalised. FELISA are distributing hybrid seedlings to 29 farmers' groups (about 990 farmers) in Kigoma region, and to date they have given away 10,000 seedlings. The value of hybrid seedlings is slowly being realised and Care International and Red Cross are asking FELISA to supply them. FELISA

employ around 60 people for weeding on their farm,

and they employ permanent nursery staff.

## Balance of Rights, Responsibilities and Revenues of Market Actors

Actors\‘3Rs’	Rights	Responsibilities	Revenues
Small-scale palm farmers	- Use of land for farming	- "Caretakers" of the land and natural resources - Production of FFB at price and quality requirements	- Subsistence from farm land - Income from oil palm trees and remaining farm products
FELISA	- Farmers' CPO (where contract is in place)	- Outgrower training - Biodiesel processing - Pay and conditions to employees - Fair contracts to farmers	- Income from selling CPO and biodiesel
Small Scale Processors	- Use of by-products (if agreed with supplier)	- Connection to local markets - Responsible disposal of 'waste'	- Income from processing - Income from by-products (if agreed with supplier)
Intermediary traders	- None	- Connection to larger markets in Dar es Salaam	- Income from selling CPO
Farmers' Groups	- Joint action - (Individual members') use of land for farming	- Negotiating with buyers - Disseminating best practice - Representing members' interests	- Members' fees - Income from selling CPO

Farmers find out the local market price by asking those returning from the market. Daily markets occur in some villages where between ten and twenty local sellers walk or cycle with the FFB or, more usually, the CPO that they wish to sell. Bulk buyers come from towns such as Bukoba, Mwanza, Kasulu, and Tabora and, as outsiders, are not well known by the sellers. The bulk buyers purchase CPO from the market or from local machines in the villages and use their own vehicles to take away the CPO. They do not provide any support to the producers, and are variously described as 'ordinary

traders', 'middlemen' or 'profiteers'. Other buyers—often Tanzanian Indians, or those working for them—work directly for businesses that produce edible oil, pharmaceuticals or cosmetics, such as the Dar es Salaam-based Mohammed Enterprises, or VOil from Mwanza. Those producing margarine and soap come to the markets themselves, as do fish fryers from Mwanza, Bukoba and Nguruka (near Tabora) who purchase the oil for frying their fish for sale. Small quantities of CPO are also sold for household consumption.

## Impact on Livelihoods Assets

The full impact of FELISA cannot yet be assessed since the company has yet to begin production at scale of either CPO or biodiesel. Nevertheless, comments can be made in relation to the types of livelihood capital.

**Human capital:** In some villages (men report that) women and men do all tasks together, although this was not always observed to be the case. It is more often the case that women collect firewood and water. Soap-making tends to be done by men, whereas the production of oil can be carried out by either men or women. Technology is basic and usage minimal. Information on farm inputs, methods and equipments is

accessible, but the problem of how to access better technologies and how to access the Mwanza and Dar es Salaam markets remains. The CPO market in Tanzania is described by one informant as 'disorganised' and 'unsophisticated', with farmers having a low awareness of how to move beyond their present (usually quite limited) market contacts. Human capital does look set to rise, however, as more farmers are trained under the outgrower scheme.

**Natural capital:** Land ownership is either private or rental. There are few areas where oil palm trees can be harvested freely by anyone, and there is no evidence of conflict over the trees. FELISA plan to intercrop

between the oil palm trees for the first two years from planting on their new plantation, but after this period monoculture will be practised as the rooting system and high canopy prevents other plants from growing well. Oil palm requires a lot of water, so thrives in the lowlands, especially in riverine areas, and where the soil is irrigated. While there is a risk in the large new plantation that water supplying nearby areas under cultivation is reduced, waste water and biomass that remains after oil extraction is to be channelled into a tank, fermented, and used to produce compost for reintroduction into the oil palm tree plantations. The process is also to be used to produce biogas for cooking, heating and the production of electricity on-site.

**Social:** Some farmers have wealthy relatives who they can rely on if their financial situation becomes difficult, although assistance with small amounts of money occurs at the local level.

**Physical:** Firewood and charcoal—the popularly used forms of energy—are generally affordable. Biomass from oil palm trees that are used as a source of energy is free but is not clean. Locally, much of the remaining biomass from the oil palm tree is used in construction. Fronds are stripped and the stem used for roofing, building fences, and for firewood. The leaves are used for brooms, and the crown bunch is dried and used for firewood. The fibre is used for kindling, and in the manufacture of hardboard in Iringa and Mbeya regions. The growing apex of the trunk is tapped to obtain a

sweet juice that is fermented to make ‘*marovu*’ palm wine.

**Financial:** The world market price of CPO has risen sharply over the last few years after large producers such as Malaysia, Costa Rica, and Indonesia cut their output to the CPO market in favour of biodiesel production. Prices have risen from US\$0.25/litre in 2005 (when FELISA’s first planting took place) to a high of US\$1.35 in 2008. At the local market a 20 litre container now sells for around US\$15.30-20.40. Middlemen make around US\$2.55 profit, and the price is around US\$1.70/litre lower if the buyer collects the oil direct from the farmer. Although the entry of FELISA as a substantial buyer holds the potential for farmers to better stabilise their income, the reluctance shown by banks to support farmer loan applications is unlikely to change. Nevertheless, farmers are generally happy as prices are rising. Last year a container was US\$10; two years ago it sold for around \$7.70. Five years ago the price was \$4.40 and \$1.60 ten years ago. Farmers pay a local village government tax of \$0.16 for each twenty-litre container. At the local market the buyer also pays a tax. Local community saving schemes (SACCOS) exist, although many small-scale farmers have limited savings because their existence is subsistence. Any profit is usually reinvested into clearing and tendering farms, paying local labourers to harvest, paying others to draw water and other manual tasks. Remittances rarely reach home in cash. FELISA plans to encourage its suppliers to open bank accounts so that they can deposit to them without marketplace transactions.

## Overall Conclusions

Oil palm has a high production potential among the oil crops, at up to 6,000 litres/ha/year. This compares to <3,000l/ha for avocado and coconut, and <2,000l/ha for brazil, macadamia and pecan nuts, and for *Jatropha*. Oil palm trees are perennial, and are grown by small-scale farmers throughout Kigoma region in western Tanzania. The downside is that palm oil plantations can be water intensive, although FELISA plan to reintroduce waste water onto their farms.

This is a favourable time in Tanzania for growers of palm oil trees and traders in CPO, so to some extent FELISA’s decision over whether to supply the biodiesel market or to stick to supplying the edible oil and cosmetics/pharmaceuticals markets (or to supply both) is one that will not affect their local suppliers since there is demand in both markets. Nevertheless, there is a risk that by producing both CPO and venturing into the biodiesel market FELISA could force up the local price of CPO. FELISA and local partner organisations should remain vigilant about this potential impact and

implement mitigating measures to avoid its occurrence. One such method could be—to use FELISA’s own suggestion—for FELISA to only purchase medium and large FFB from the small-scale outgrower farmers, leaving smaller FFBs for local processing and consumption. The potential for FELISA to support rural livelihoods does exist, most notably in their proposed outgrower scheme that—in exchange for a more reliable source of extra crops to supplement supplies from their plantations—promises to offer support from a staff experienced in improved methods for the production and processing of palm oil. The staff are also familiar with the local and international CPO and (to a lesser extent) biodiesel markets. Here FELISA is able to provide another avenue to markets that presently farmers feel they are lacking when dealing only with bulk buyers locally. That said, there is no guarantee with FELISA that the oil (whether CPO or blended biodiesel) will end up in Tanzania

<b>Initiative name</b>	<b>Case 6 – Kenya Afforestation Charcoal</b> <i>Community Driven Commercial Afforestation</i>
<b>Location</b>	<i>Central Uyoma, Madiany Division, Rarieda District, Nyanza Province, Kenya, East Africa.</i>
<b>Initiation Date and Duration</b>	<i>September 2002. Six years by end of September 2008.</i>
<b>Funder(s)</b>	<i>Initially Thuiya Enterprises Limited; now Embassy of Finland and the Christian Agricultural and Related Professionals Association (CARPA).</i>
<b>Project Initiator</b>	<i>Youth to Youth Action Group and Thuiya Enterprises Ltd.</i>
<b>Overall support budget</b>	<i>US \$ 15,000 in 2007 and US \$ 22,000 in 2008 (this increases annually)</i>
<b>Energy Output</b>	<i>100 tonnes of round wood or 30 tonnes of charcoal per hectare – under six years rotation.</i>
<b>Area of land</b>	<i>Currently about 200 hectares.</i>
<b>Beneficiaries</b>	<i>Farmers from beans and groundnuts - US\$ 385,600 over the 6yr cycle; Honey - US\$ 5,400 per year from 60 hives. Households, energy saving US\$ 20,640p.a. Charcoal transporters, charcoal wholesalers - US\$ 214,500 in 6 yrs and retailers US\$ 321,400 in 6 yrs, Community based organisations e.g. RAID US\$160 per ha from raising seedlings. The total financial benefits for all the key actors are about US \$ 2,096,911.</i>

## Background and Context

Although potentially renewable, forest resources in Kenya are exploited at a higher rate than their supply is renewed, rendering them non-sustainable in practice. As a result of this exploitation, Kenya's forest resources cover only around 6% of the country's 58.2 million hectares and are estimated to be decreasing by 2% annually. Forest cover is very low compared to the United Nations' globally recommended 10% for ecological stability of the country. In 2002, wood fuel demand and supply in Kenya was estimated to be 32 million tonnes and 16 million tonnes respectively. This is a 50% deficit, drawn from standing wood stocks, leading to deforestation, and environmental degradation. Besides the suffering of women and children who bear the burden of providing household fuel, increased deforestation reduces the forests' carbon sink capacity, contributing to changes in climate and rainfall patterns that interfere with food production and security. Increased water runoff contributes to greater soil erosion and downstream floods.

Firewood is mainly a rural fuel with over 90% of Kenya's rural population dependent on it. Charcoal made from wood, on the other hand, is produced by rural people as a source of income. Charcoal is mainly an urban fuel, with 82% of the urban population using it. Increasing urbanisation of the population (7.4%) and the subsequent increase in charcoal consumption has led to an increase in deforestation. In the 1980s and early 1990s, charcoal was mainly obtained from natural

woodlands. However, over time, natural forestry resources have declined drastically necessitating deliberate intervention to increase resource supply. Worse still, over 99% of the charcoal produced in the country is processed in traditional earth kilns with a 10% conversion efficiency, so for every 100 kilogram of wood, only 10 kilograms of charcoal is obtained, despite there being technologies with 30% efficiency that can yield three times more charcoal for the same wood.

Although the Lake Victoria basin region is endowed with large tracts of productive land, and other natural resources, national poverty surveys consistently show the districts around the lake to be amongst the poorest in Kenya. Determined to make a difference in this region, the Youth to Youth Action Group, with financial support from Thuiya Enterprises Ltd., initiated the community-driven commercial afforestation project in 2002, in Madiany Division, to enhance the livelihoods of the local communities. The project promotes the growing of *Acacia xanthophloea* and *Acacia polyacantha* for charcoal. *Acacia xanthophloea*, commonly referred to as Naivasha thorn or fever tree (Alii in Luo), is a fast growing acacia species that grows at a rate of 1.0 metre to 1.5 metres per year, thriving at altitudes of 600-2100 metres above sea level, and ideally suited to near swamps, along rivers or lakesides.

### The Initiative Market Map

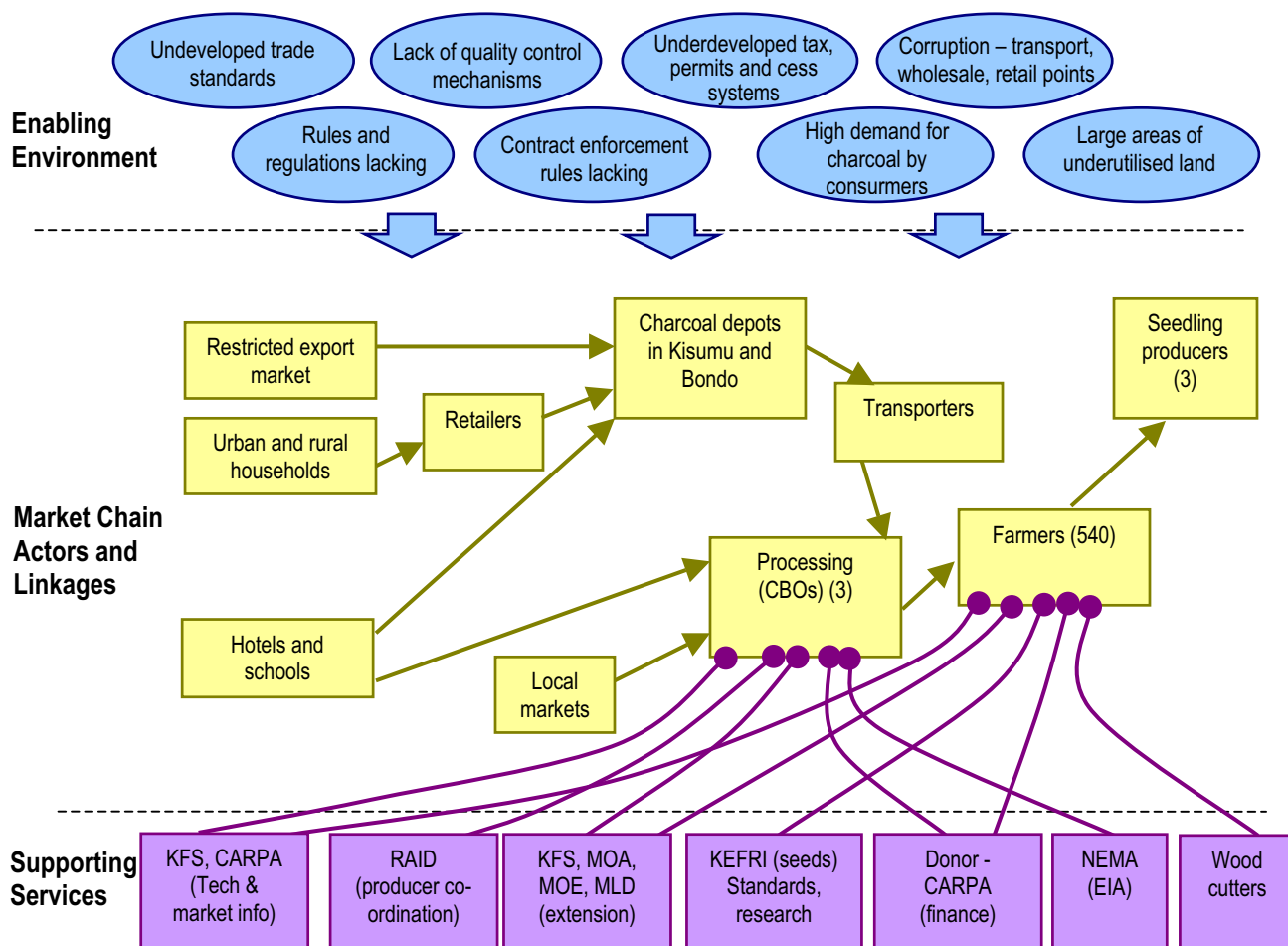

Through historic neglect and the perceived negative environmental impact, many **Market Actors** in the charcoal value chain do not engage openly in the charcoal industry, although the situation is changing for the better. This project has demonstrated that it is possible to produce and market charcoal sustainably. Currently, there are no formally registered charcoal producers, transporters or marketing institutions around Lake Victoria; the linkages described are in the process of formation. This project is coordinating registration of charcoal producers within Madiany division. There is limited research on the potential in the industry and project facilitators plan to lobby for more research and establishment of stakeholder associations and linkages.

An **Enabling Environment** is needed as policies and regulatory issues are slowing down emergence of a dynamic charcoal sub-sector. Although not illegal in Kenya, charcoal is treated as semi-illegal because of certain presidential decrees of the 1990s. Charcoal cannot be exported without authority from the Ministry of Forests and Wildlife. Corruption is endemic, especially at the transport stage, and those who want to engage in non-corrupt business shy away from it. Too

many actors in the regulatory system – chiefs, police, county council officers etc. leads to confusion in the industry. With no developed standards for charcoal, the same price will be charged for differing weights. Charcoal from lightweight species like cypress, and charcoal from very dense wood, such as Acacias, is sold at the same price. With no law to facilitate enforcement of production, transportation and marketing contracts, the participation of the private sector in contracting charcoal producers is limited. Since only those individuals and communities with secure land tenure can engage in its production, this excludes many landless or young families.

**Supporting Services** are provided by the Rachar Agroforestry Initiative for Development (RAID), a farmer umbrella Community Based Organisation. The Embassy of Finland and the Christian Agricultural and Related Professionals Association (CARPA) provide technical backstopping, some funding, and resource mobilisation for groups. Moi University and the Kenya Forestry Research Institute (KEFRI) provide leadership in research. The Ministries of Forests and Wildlife were involved through the Kenya Forest Service and the

Ministry of Agriculture and Livestock Development provides extension services. The Ministry of Energy was involved in choosing the charcoal processing

technology. Transporters provide support services and form part of the market as intermediary traders.

## Relationships between Market Actors

	Seeds & Research (KEFRI)	Seedlings Producers (RAID)	Farmers	Wood cutters	Charcoal processors	Charcoal transporters	Charcoal wholesalers & retailers	Local Authority/ Govt	Charcoal users
Seeds & Research (KEFRI)									
Seedlings producers (RAID)	Fair - financial, technical								
Farmers	Good - technical	Good - technical, formal							
Wood cutters (employed by farmers)	None	None	Good - financial, informal						
Charcoal Processors	Good - technical, Formal.	None	Good - financial, informal	None					
Charcoal Transporters	None	None	None	None	Good - financial, informal				
Charcoal wholesalers and retailers	None	None	Fair - financial, informal	None	None	Good - financial, informal			
Local authority/Government	None	None	None	None	None	Poor - regulatory, financial	Poor – undefined		
Charcoal consumers	None	None	None	None	None	Poor - financial, informal	Good - financial, informal	None	

Although not fully developed, the relationship among the actors is generally good. This initiative has contributed to the creation of demand-driven research and extension insofar as farmers previously planted trees without sufficient knowledge on spacing, management practices, expected wood yields and efficient charcoal processing technologies. They later requested technical support from KEFRI on these issues. KEFRI is now carrying out trials to determine the appropriate spacing and management regimes for optimal yields. Preliminary results have given general indications on some of the requirements for higher wood and charcoal yields. As indicated in the Table above, most of the relationships are informal. The initiative is working on modalities to formalize the key relationships. Those targeted include training teams of

charcoal burners, by developing formal charcoal burning agreements with farmers, developing standards and trade rules. In this initiative, it is only the farmers who planted trees who are allowed to harvest them for charcoal. RAID ensures that this rule is enforced by producing and distributing seedlings to farmers, and recording all those who have planted trees. Once produced, any interested buyer can purchase charcoal from the producers, and transport it to any area of their choice. In the near future, RAID is expected to identify and negotiate for better prices on behalf of the farmers. The relationship between farmers & charcoal processors is good. The farmers get a service (charcoal from wood) & the processors get income from the farmers.

## Balance of Rights, Responsibilities and Revenues of Actors

Actors/3Rs	Rights	Responsibilities	Revenues
KEFRI	-Carry out research on suitable charcoal species	-Generate appropriate technologies. -Provide certified tree seeds	-Income from sale of information and seeds
RAID (CBO)	-Facilitate farmers pooling sales to reduce transaction costs. -Produce seedlings for farmers	-Mobilize / engage small scale farmers -Ensure sufficient seedlings for all the registered farmers.	-Membership fee -Marketing fee -Income selling seedlings
Small scale farmers	-Use of land for farming -Sale of wood products	-Caretakers of land and natural resources	-Income from farm produce including wood products.
Youth/Women groups (Seedling producers/ Charcoal processors)	-Produce seedlings	-Ensure quality seedlings	-Income from selling seedlings
Wood cutters	-None as casual labourers	-Cutting wood	-Wages from cutting wood
Charcoal processors	-Convert wood into charcoal	-Ensure efficient transformation process	-Wages processing wood into charcoal
Charcoal transporters	-Transport charcoal from the production centre to the urban wholesale market.	-Ensure maintenance of charcoal quality while on transit.	-Income from transporting charcoal
Charcoal traders	-Selling charcoal	-Ensure certified scales and weights	-Income from selling charcoal
Local Authority	-Collect fees for infrastructure use such as cess (tax paid by transporters to Local Authorities for transporting charcoal)	-Ensure availability of selling points e.g. Depots	-Income from cess
Charcoal consumers	-Right to purchase charcoal	-Use energy efficient utilisation technologies	-Income saved from using less charcoal
Forest service	-Provide extension services -License production and transportation of charcoal	-Provide appropriately packaged technical information -Ensure sustainable sourcing of charcoal by issuing certificates after inspection.	- Income from license for production and transportation

Farmers have the **Right** to farm while RAID has the right to produce seedlings. Farmers risk losing their tree crop through drought or floods. RAID guarantees trees for a month, so risks losing seedlings transporting or transplanting. Men usually sign the initial contracts with Thuiya Enterprises Ltd, with their sons rather than wives, claiming insecurity about their wives' permanence. Some women hire and plant their own land.

In terms of **Responsibilities**, production was initially funded by Thuiya Enterprises Ltd. on a contract basis. Two risks emerged: lack of legislation; risk of competition. The new arrangement allows farmers, supported by government, NGOs or through loans, to sell wood for the best price.

**Revenues** come to farmers from short seasonal crops for the first and second year. In the third to sixth year, they get income from honey, poultry and dairy goats. In the third year, farmers are loaned one beehive for every 500 Acacia trees planted, with an anticipated yield within three months, providing interim income. The farmer repays RAID for the beehive with 2 kg (US \$ 6) of honey from every harvest (US \$ 24 per year) for three years. Dairy goats and poultry will be introduced in 2009. The money paid to RAID is used as a revolving fund for buying more beehives. The youth benefit from raising tree seedlings, women from trading in efficient cooking devices, beans and groundnuts, men are mainly involved in tree planting, management and charcoal processing. Women get firewood from tree tops and smaller branches.

## Analysis of the Livelihoods Outcomes

In terms of Human Capital, all participating farmers have acquired new knowledge on tree-husbandry for charcoal, bee-keeping and energy conservation technologies. They have harvested ~270 tonnes of grain, for food or sold for income. The added knowledge and skills will reduce vulnerability of the community. They have gained a market for products and equitable returns for individual actors. The knowledge and skills will remain within the community as a resource, while others can benefit from both the documented research outcomes and study tours.

The 200 hectares planted have enhanced Natural Capital, a significant increase in forest cover. The two indigenous tree species are leguminous, fixing nitrogen and improving soil fertility, so the land has higher ecological value without depleting biodiversity. The trees have an impact on the micro-climate, conspicuous during the dry season. Although quantitative data are unavailable, forest cover increases the carbon sink capacity of the area.

Social Capital increases as members interact and build trust with each other and outsiders. RAID is now vertically linked to networks like the Embassy of Finland, CARPA, Kenya Forest Service and other potential supporters. Horizontally, the local network has brought participating groups together. All group members have registered with the Ministry of Social Services and leaders are learning to be strong leaders. Farmers feel increased status, interacting with outsiders, building their own capacity and that of others. They have negotiated with Constituency Development Fund (CDF) officials, for support building an office and attracting support for cotton production.

## Overall Conclusions

This project has potential to improve the livelihoods of the rural poor because of the high demand for charcoal. The initiative does not require high capital investments and can be integrated with other enterprises to ensure sustainable access to food and income benefits. The current initiative has not maximised its potential because it is still in its pilot phase and the enabling business environment is not well developed. When fully operational, and the appropriate enabling environment in place, this initiative can maximize its potential in supporting rural livelihoods especially if contractual business arrangements are adopted. This will assure producers of a regular and predictable income and also

Physical Capital is increased by the trees themselves, which are used as collateral by farmers e.g. one beehive is given for every 500 trees planted. Energy security has improved in villages and urban centres. The community has bought land for offices. They own six charcoal processing kilns, accessible to all members. Farmers may choose to sell the wood to anyone, but for charcoal, wood harvesting has to be certified by a Forest Service Officer. Seedling for the three tree nursery sites (producing over two million seedlings) have been provided by the Ministry of Forests and Wildlife demonstrating the good working relationship with the government.

Financial capital from the 200 hectares will provide key actors in the chain with an income from charcoal of US\$1,028,571 after six years. Firewood savings through energy efficient stoves will save US\$20,640p.a., fast-growing crops US\$385,600p.a., transport services US\$94,200p.a., wholesaling of charcoal US\$214,500 and retailing of charcoal US\$321,400. Honey will generate US\$ 5,400 per year for the 60 hives. The number of hives is expected to rise to 1000 hives earning US\$ 90,000 per year. The coordinating CBO, RAID, gets an income of US\$160 from the donor for raising seedlings for every hectare of trees planted. To date it has earned US\$ 32,000 from tree seedlings. The total financial benefits for all the key actors are about US\$ 2,096,911 (charcoal included) in the six-year rotation period. Sustainability of the indicated livelihood outcomes can be attained if the weaker components of the charcoal value chain are strengthened to ensure fairness in distribution of the benefits along the value chain and enhancing the enabling environment.

assure contractors of a steady supply of the product. Despite the presence of the large market, if those farmers who produce charcoal find the business environment is not conducive for them to sell profitably, and are stressed by the current corruption and harassment from the regulators, it is easy for the initiative to collapse. However, if the enabling environment improves, and sufficient investment is provided to reach a threshold level where the initiative expands naturally, then the project will be very successful. Since it is a business enterprise, whose every activity is valued, sustainability is assured provided a market exists.



<b>Location</b>	<b>Case 7 – Ethiopia Ethanol Stoves</b> <i>Addis Ababa, Kebribeyah &amp; Awbere, Ethiopia, Capital city &amp; Somali region</i>
<b>Initiation Date and Duration</b>	<i>2004, 4 years</i>
<b>Funders</b>	<i>Shell Foundation, UNHCR, USEPA, IRC, LWF</i>
<b>Project Initiator</b>	<i>Finchaa sugar factory and Ministry of Trade and Industry</i>
<b>Overall Budget</b>	<i>973,062 In US\$</i>
<b>Output</b>	-
<b>Area of Land</b>	N/A
<b>Beneficiaries</b>	<i>2650 households in displaced communities and in Addis Ababa who use ethanol for cooking</i>

## Background and Context

Ethiopia has a total of 1.14 million square kilometres and a population of 71.1 million in 2004. It is the ninth largest African country in size and the second most populous. The overall population density is 62 persons per square kilometre. Approximately 16 percent of the country's population resides in urban areas. Ethiopia is one of the poorest countries in the world. This is reflected in low per capita income (US\$ 97 in 2003), very poor social indicators, poor output from the productive sectors, poorly developed infrastructure and a degraded environment.

The country's economy is based predominantly on rain-fed subsistence agriculture. Gross Domestic Product (GDP) at market prices in 2003 was US\$6.7 billion. The agricultural sector contributed 43%, with the manufacturing industry, including small-scale and handicrafts, providing 12 percent and the service sector about 45 percent.

The most widely used fuel for cooking in Addis Ababa is kerosene (42.2%) followed by fuelwood (29.4%). Charcoal, LPG, electricity and residues are used by a much smaller section of city households. The primary cooking stove used in Addis Ababa is the single burner kerosene wick stove. This stove is imported from the Far-East and sells for about \$5.00. The second most important fuel in the city, fuelwood, is used when cooking over an open fire.

As one moves from Addis Ababa to other urban centres, access to modern fuels declines and use of traditional fuels increases, so fewer households use modern energy in the other urban centres. At national level, kerosene is used as the primary cooking fuel by only 14% of urban households compared with 42% in Addis Ababa. Similarly, only 2-3% of households reported using LPG and electricity as their primary cooking fuel at the national urban level compared to 6-7% for Addis Ababa.

In the case of kerosene, the number of users has dropped substantially in both Addis Ababa and other towns between 2000 and 2004. The share of kerosene has declined from 66% to 42% for Addis Ababa and from 22% to 14% at the national urban level. As in Addis Ababa, the reduction of kerosene use is accompanied by an increase of fuelwood use. The recent government policy to remove the kerosene subsidy has aggravated the trend, and the kerosene price rose from \$0.57 to \$0.86 per litre.

The indoor air pollution (IAP) monitoring carried out by Gaia Association in the homes of Addis Ababa residents that use primarily kerosene, fuelwood and charcoal showed high concentrations of carbon monoxide (CO) and particulate matter (PM) which have been shown to be harmful to health. Household energy scarcity and indoor air pollution are widespread problems in Ethiopia.

In addition to urban homes, Gaia Association has completed cooking energy and indoor air pollution studies in homes in refugee camps in the north (Tigray), west (Gambela) and east (Jijiga) regions. These homes rely entirely on solid biomass fuels. The project has found extremely high levels of pollution in these homes.

Ethiopia established an ethanol manufacturing plant called the Finchaa sugar factory in 1999. Seeking potential markets for the ethanol, Project Gaia was invited to do pilot studies in Addis Ababa households in 2004. Since then, Gaia has been working to promote ethanol as a household energy fuel. In recent years the government of Ethiopia has planned and started to use ethanol for automotive fuel (gasoline) blending. Ethanol distilleries being built by the government have a promising potential to cover ethanol demand from both the household and transport sector. The government placed its plan for ethanol in the Ministry of Mines and Energy's Biofuel Development and Consumption Strategy. According to the plan, the household market will get an adequate share of the ethanol produced.

Results of a pilot study have showed that the project households readily accept the new cooking technology (called the 'CleanCook' stove), and ethanol fuel, and that ethanol could effectively substitute for kerosene, for charcoal and for fuel wood use, where the cooking task could be completed with the ethanol stove. Thus, ethanol could provide a new fuel to households, with the potential to mitigate household energy scarcity while increasing stove safety and reducing indoor air pollution.

In 2007, the Gaia Association was formed as an autonomous Ethiopian registered NGO. It began working with a private sector partner to facilitate local manufacture of CleanCook stoves, to reduce the cost of the stove to Ethiopian consumers. Work with the private sector partner is financed by the partner, Makobu Enterprises PLC, and by a 'commercialisation grant' from the United States Environmental Protection Agency (USEPA) under its Partners for Clean Indoor Air (PCIA) programme. This effort is also being assisted by Project Gaia, Inc., a U.S. donor-supported non-profit agency.

### The Initiative Market Map

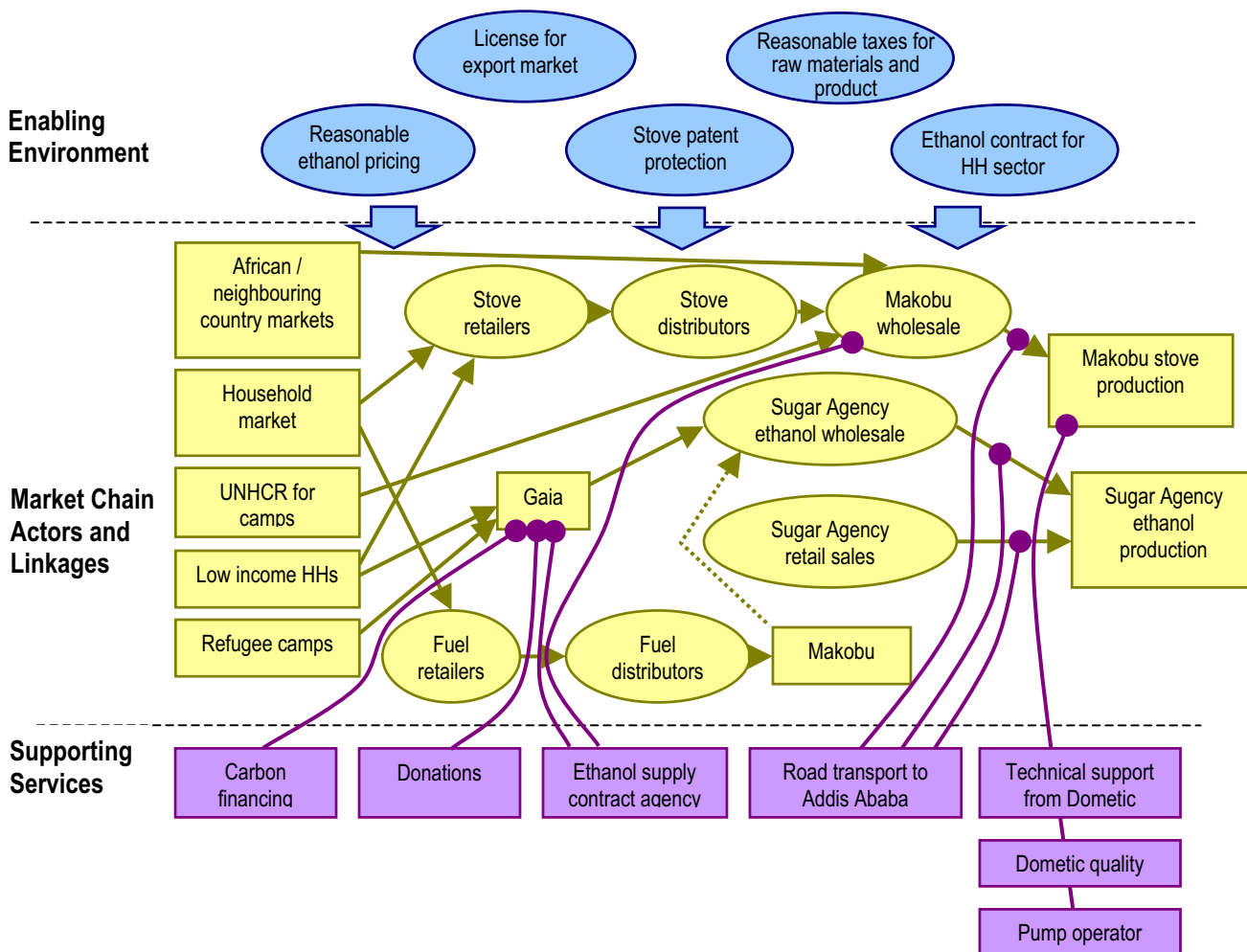

With respect to the enabling environment, the Ethiopian government has determined that locally manufactured ethanol will be used solely within Ethiopia, thus assuring domestic supply. Gaia Association has worked closely with the government and the sugar agency to ensure a reliable supply chain for the fuel.

Ethanol supply at a reasonable price, and realistic taxes on raw materials and goods are an essential part of the enabling environment for the ethanol stove market in Ethiopia. The current 8 million litres ethanol production in the country is not yet enough to cover the large household market, but the country has a promising ethanol production plan for the coming years through expansion and the construction of new distilleries. According to the Ethiopian Sugar Agency projected annual ethanol production will reach 128,849,000 litres in the next four years from the current 8 million litres. This annual production of ethanol will serve both the households and the transport sectors.

In terms of supporting services, Makobu stove production is supported technically by the original stove manufacturer Dometic AB, a longstanding Swedish company, for consistent product quality. The patent of

the stove will be protected so that investments made in stove design and the manufacturing plant will not be jeopardised.

Makobu enterprises has imported and sold stoves for the last five years, and is now starting to produce stoves locally in a custom-built new factory 80Km from Addis Ababa, supported by Dometic. A wholesale outlet in Addis Ababa enables different institutions and retailers to purchase stoves from Makobu wholesale. These include the UNHCR for its refugee camps, and distributors within Ethiopia and in neighbouring countries. Gaia Association purchases stoves from the wholesale market, whilst households in Addis Ababa, and other cities within the country, purchase stoves from retailers and the retailers from the local distributors.

Stoves purchased by Gaia Association will be used for subsidised sales. As ethanol burns very cleanly, Gaia is currently in discussion with carbon financiers about finance to allow the stove to be subsidised for those living in poverty. Low-income households in Ethiopia will get stoves at a subsidised price from Gaia. Gaia subsidy will be covered by carbon finance and donations.

## Relationships between Market Actors

	Gaia	Makobu	Dometic AB	Ethiopian Sugar Agency	UNHCR
Gaia					
Makobu	Excellent - formal				
Dometic AB	Excellent - informal	Excellent - formal, technical,			
Ethiopian Sugar Agency	Excellent - formal	Poor - informal	None		
UNHCR	Excellent - formal, financial	None	None	Excellent - informal	

Gaia Association has been working with Makobu Enterprises PLC to produce CleanCook stoves in Ethiopia for around five years. The two partners have a bilateral agreement that has helped them to work on establishing a local stove manufacturing plant.

The partners have have a mutual fund from USEPA (United States Environmental Protection Agency) to further the stove production and commercialisation of the stove. Gaia and Makobu are working closely in advocating ethanol for household energy.

Dometic AB is working with both Gaia and Makobu on patent rights, stove redesign for adaptation, and local manufacturing. Gaia has had an excellent relationship with the Ethiopian sugar agency (responsible for production and distribution of ethanol) for the past four years.

Gaia has been contracting ethanol from the sugar agency for pilot studies and projects in the refugee camps. Now Gaia is working to sustain and strengthen this relationship and also to strengthen Makobu's

relationship with the agency. Makobu's strong relationship with the agency is necessary to enable Makobu to be a future wholesale ethanol buyer.

Gaia has a formal Implementing Partner relationship with the UNHCR liaison office in Ethiopia to supply CleanCook stoves and ethanol in the refugee camps.

UNHCR will continue to buy stoves produced locally, and this will initiate a relationship with Makobu. UNHCR has a very good relationship with the sugar agency, and has greatly assisted Gaia's advocacy of ethanol for household sector.

## Balance of Rights, Responsibilities and Revenues of Market Actors

	<b>Rights</b>	<b>Responsibilities</b>	<b>Revenues</b>
<b>Gaia</b>	-Using ethanol for household in different project sites	-Promoting ethanol for household energy -Advocating to secure ethanol for household energy	-Donations -Carbon financing
<b>Makobu</b>	-CleanCook stove production and selling -Ethanol distributing	- Plant construction for stove manufacturing -Supplying CleanCook stoves and ethanol	- Income from CleanCook stove sales - Income from ethanol distribution -Carbon financing
<b>Dometic AB</b>	-CleanCook stove patent right	-Technical support to Makobu	-Income form patent transfer to Makobu
<b>Ethiopian Sugar Agency</b>	- Selling ethanol	-Ethanol allocation to household sector	-Income from sale of ethanol
<b>UNHCR</b>	-To get supply of CleanCook stoves and ethanol in the refugee camps	-Stove and ethanol purchase for refugee camps from Makobu and Sugar Agency	-Clean and safe energy to the refugees

Gaia Association has the responsibility to work towards promoting and allocating ethanol and the ethanol fuelled CleanCook stove for household energy. The Association has promoted its pilot study results in Addis Ababa and the success of the project in refugee camps over the past two years. Makobu Enterprises produces CleanCook stoves and distributes ethanol allocated for household energy, penetrating the market through Gaia Association's promotional work. Gaia Association and Makobu Enterprises have signed an agreement detailing the responsibilities of each entity in achieving their shared goals. Dometic AB will provide technical know-how needed by Makobu to produce CleanCook stoves.

The Ethiopian sugar agency ensures a sufficient amount of ethanol is allocated for the household sector through contracts with Gaia and Makobu. UNHCR is responsible for buying stoves from Makobu Enterprises through Gaia Association for its Clean and Safe Energy programme in the refugee camps. UNHCR and Gaia Association signed an agreement that has been renewed every year in January starting from 2006 to implement the program in the refugee camps.

Gaia Association has the right to use allocated ethanol for its promotional projects in Addis Ababa and refugee camps so that ethanol and the CleanCook stove is promoted widely. Makobu Enterprises will have the

opportunity to produce CleanCook stoves exclusively in Ethiopia and to distribute ethanol allocated to the household sector. Dometic AB will have its patent right for the CleanCook stove protected, while Makobu produce the stove locally. The sugar agency has the right to sell ethanol at a price it determines will enable Ethiopian households to use ethanol for cooking. UNHCR will have the right to get CleanCook stoves and ethanol from the local market for the refugee camps.

Gaia takes the risk in promoting ethanol for household energy and convincing the sugar agency in securing ethanol for household sector. Makobu takes the risk of erecting the plant for the stove manufacturing in a monopoly ethanol market.

Gaia Association and UNHCR are organisations which are not looking for profit; with incomes derived from donations, and carbon financing goes back to project sustainability either in the refugee camps or Addis Ababa. Makobu Enterprises produces stoves and facilitates ethanol distribution; the profit made keeps it in business for sustainable stove production, employment, and ethanol distribution. The Ethiopian sugar agency produces and sells ethanol; the profit made keeps it in business also. Dometic AB gets income from stoves sold by Makobu for a pre-agreed period of time.

As Makobu, Dometic AB and the sugar agency are profit-making companies, they make investments taking the risk of market competitiveness in the existing fuel market of Ethiopia. Gaia also makes investments in stove production, taking the risk of ethanol supply and

market competitiveness to realize clean and safe household energy in Ethiopia. UNHCR takes the least risk, but requires a sustainable reasonable price of ethanol as its only investment is in purchase of ethanol stoves.

## Analysis of Livelihoods Outcomes

The project has brought change to the lives of Ethiopians and refugees through creating clean indoor air, stove production jobs, reducing deforestation, new jobs in ethanol distilleries and finally stove and ethanol distribution.

The refugee camps in the Somali region of Ethiopia have already started to value all the benefits of the project. The ethanol distillery at the Finchaa sugar factory has already created job opportunities. Three other new distilleries are in the process of starting up production of ethanol, which will ultimately create many more job opportunities.

When households start to use ethanol in Ethiopia, the country will save foreign currency on kerosene. Stove and ethanol distribution chains will have significant job opportunities for many people. A successful full project scale up of the Gaia/UNHCR project in Kebribeyah refugee camp already demonstrates the project benefits.

Kebribeyah refugee camp is located in the Eastern part of Ethiopia, some 650km from the capital Addis Ababa, in the Somali region. The UNHCR Kebribeyah Camp, established in 1991, accommodates approximately 17,000 Somali refugees, representing various clans. The UNHCR, who are implementing partners with the Ethiopian government, work together to meet the needs of the refugees. The refugees get a ration of food every month according to their family size, and other needs such as a health facility, schools, housing and recreation centres are being supplied by UNHCR partners.

The refugees were formerly collecting firewood to meet their household energy needs. In some cases, refugees

would sell their rations to buy charcoal for cooking. Due to firewood collection from the nearby forests, the area had become deforested, and since mostly women and children collect firewood, they were forced to face physical attacks and in some cases rape while they travelled long distances from their homes. As well as causing deforestation, firewood collection has caused tension between the local and refugee communities about the already scarce firewood in the area.

After completing a pilot study in the camp, Gaia introduced CleanCook stoves and ethanol throughout Kebribeyah camp. The consecutive scale-ups consisted of 1790 refugee families in Kebribeyah and 800 in the newly-opened Awbere refugee camp.

According to a study conducted by the Ethiopian Rural Energy Development and Promotion Centre, each household in Kebribeyah used on average nearly 400kg of wood every year for cooking. This has been reduced in each of the 1790 households by 93% after Gaia Association introduced clean burning ethanol stoves.

Women had to travel an average of 8 km to collect firewood before being introduced to the new cooking technology; this has now been reduced by 73%. Conflicts with local people and attacks are also reduced.

Indoor air pollution tests facilitated by Gaia Association under the leadership of University of California, Berkley revealed 94% and 79% reduction in kitchen concentration of Particulate Matter (PM) and Carbon Monoxide (CO) respectively.

<b>Initiative Name</b>	<b>Case 8 – India Jatropha Electrification</b> <i>Remote Village Electrification through Biofuels</i>
<b>Location</b>	<i>Ranidehra, Kabirdham district, Chattisgarh.</i>
<b>Initiation date and Duration</b>	<i>October 2004 – September 2009</i>
<b>Project Initiator</b>	Ministry of New and Renewable Energy , <i>British High Commission (BHC) &amp; SDC</i>
<b>Overall Budget</b>	<i>\$ 88,889 US</i>
<b>Energy output</b>	<i>Generating Capacity: 3* 3.5 KVA with 7.5 KVA Back up capacity</i>
<b>Area of Land Under Cultivation</b>	<i>44,000 saplings planted along Road side and farm bunds.</i>
<b>Beneficiaries</b>	<i>107 households, 535 tribal people belonging to Gond and Baigas Community.</i>

## Introduction

There is a large disparity in the usage of energy in the world and while per capita utilisation of energy is high in developed countries in many developing countries like India the remote rural areas are deprived of any form of energy source. Over 2 billion people around the world do not have access to “modern” forms of energy such as electricity and liquid fuels. In India, the Rural Electricity Supply Technology (REST) mission of the Ministry of Power (MOP) envisages “power for all” by 2012. The mission targets 100% rural electrification but only 43.52% of rural households have access to grid power according to the 2001 census. The electricity supply is also characterised by frequent black outs and erratic voltage levels. Energy supply to urban areas gets prime importance. Use of renewable energy sources could be instrumental in mitigating energy poverty and improving socio-economic conditions of rural people, especially in remote rural villages where extension of the grid is unviable.

However, in spite of various initiatives by the Government, renewable energy technologies are far from mainstreamed. The major barriers include: limited financing to defray high up-front costs associated with developing renewable energy projects; entrepreneurs’ unfamiliarity with how to structure commercially viable business; tough competition from subsidised conventional energy sources that lower the market price for electric and thermal power; market penetration costs; and at times, a less than conducive policy environment<sup>1</sup>.

Nevertheless, rural electrification through unconventional energy sources is gaining prominence and needs a coordinated effort among various stakeholders to make it a viable option. A leading effort is the initiative of Winrock International India (WII) to electrify one remote tribal village through the use of biofuel using non edible oil derived from tree borne oil seeds in the state of Chattisgarh.

The objective of this initiative was to demonstrate the technical and financial viability of running diesel generation sets using vegetable oil as fuel in place of conventional diesel to provide electricity in remote villages. The initiative aims to build upon an existing initiative of WII/Ministry of New and Renewable Energy (MNRE) by designing and implementing a replicable model of remote village electrification via biofuels. The project village, Ranidehra is in the Kabirdham district of Chattisgarh. The district is surrounded by Dindori in the north, Bilaspur and Durg in east, Rajnandgaon in the south and Balaghat in the west. Ranidehra is a predominantly tribal village (Gond and Baigas community) of 110 households. These tribal communities depend on agriculture as their livelihood. Non Timber Forest Produce (NTFP) trade and wage labor are the alternatives to agriculture. 46% of the population practice subsistence agriculture. The village is underdeveloped owing to its poor connectivity, high tribal population and primitive agriculture practices.

## The Initiative Market Map

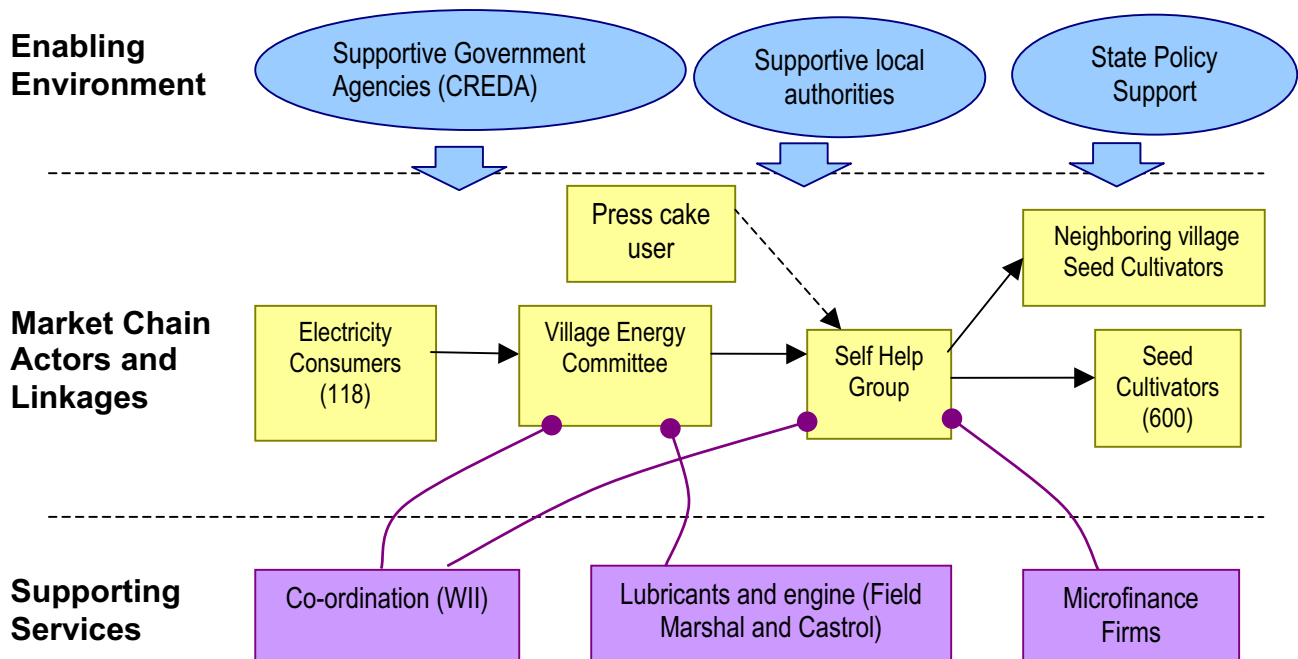

Recognising the difficulty in energy access of the remote village and to foster self sustainability, WII with the support of MNRE and BHC set out to illustrate the direct use of Jatropha oil for rural electrification. With the assistance from the Kabirdham district Administration, WII selected Ranidehra as the most suitable site to experiment. Field Marshal had provided the necessary equipments and Castrol India supplied the lubricant that enabled the use of conventional diesel engine with some necessary modifications to produce electricity. The project initiation phase had required some serious efforts to convince the local community about the project feasibility. A series of community mobilisation efforts and awareness generation camps resulted in the formation of a Village Energy Committee (VEC) and a women's self help group in the village. VEC had decided to undertake Jatropha plantations in the barren land, private farm bunds, kitchen gardens etc. Successively, 24,000 Jatropha saplings were planted in the first phase and 20,000 in the second. Villagers put together Voluntary labour to plant the saplings and WII granted the sapling costs. The saplings were sourced from the Forest Department. The land for the establishment of power house has been leased to the VEC by the district officials on request from the local panchayat. The power house comprise of an oil extraction section, a power generation room, a rice de-husking chamber, a power distribution room and a large storage area for

Jatropha seeds and food grains. The oil extraction section comprises of an oil expeller and filter press. The power house is strategically located so as to enable equitable power distribution and equidistant transmission line extension to the hamlets and easy accessibility. The power house also serves as the place for village meetings. Active dialogue and negotiation is going on to provide the financial support from microfinance firms who would support the woman self help group in providing the necessary funds to purchase the food crops which are in turn stored in the power house for selling in conducive market situations. The power unit uses 1 tonne of oil seeds per month for 3 hours of domestic and 3.5 hours of street lighting per night. The demand of 1 tonne of seeds for power generation is not currently met through local production from Ranidehra and neighbouring villages. WII provides the necessary funds to purchase seeds from open market to fulfil the total requirement. As the plantation is too young to bear fruit and in some cases thick undergrowth and threat from poisonous snakes has made collection of fruits a daunting task.

The by products, the press cake, is sold in the open market as a domestic fuel and to fuel small scale commercial ventures like brick making etc. CREDA is testing the possibilities of using the press cake to generate biogas. Use of press cake as green manure is still under scientific scrutiny owing to uncertainty as to its possible toxicity.

## Relationships between Market Actors

	Seed Collectors	Self Help Groups	Village Energy Committee	Electricity Users	Equipment and Lubricant	WII
Seed Cultivators						
Self Help Groups	Good, Formal Financial					
Village Energy Committee	Good Formal	Good formal				
Electricity Users	Good Formal	Good Formal	Good Formal			
Equipment and Lubricant Provider	Good Informal	Good Formal	Good Formal	Good Informal		
WII	Good Formal	Good Formal	Good Formal	Good Formal	Good Formal	

The initiative brought a successful partnership between WII, equipment and lubricant provider. The experiments undertaken in WII were directed to use Jatropa oil in conventional diesel engines as fuel instead of converting into Biodiesel. The pilot trials with technical support from PM Diesels (Field Marshal) and Castrol India Ltd confirmed the successful utilisation of Jatropa oil directly as fuel. Further, community mobilisation effort by WII established Village Energy committee (VEC) for the proper administration, accountability and accounting of the initiative. VEC is a registered body consisting of 14 members including 6 women. The members are representatives from the local community and are

elected to the committee. Seed collection operation is monitored by VEC while woman self help group assists VEC in seed collection.

The Village Energy Committee (VEC) takes care of all the energy operation activities. Electricity users pay the VEC in cash monthly for energy usage. Rs. 20/- (\$0.44) per 11 Watt Compact fluorescent light bulb and Rs. 30/- (\$0.67) per plug point is collected from the villagers. The villagers also benefit from the rice de-husking machine which charges Rs. 25/- (\$0.55) per 50 kg of Rice where as it costs Rs. 70/- (\$1.55) for the services of the nearest rice mill in the town.



## Balance of Rights, Responsibilities and Revenues of Market Actors

Actors'3 Rs'	Rights	Responsibilities	Revenues
Seed Collectors	- Land rights for cultivation	- "Caretakers" of the land and natural resources	- Subsistence from the seed - Selling of the food crop.
Self-Help Groups	- Involvement in the decision making process - Access to the Electricity on regular payment	- Procurement and collection of seeds and food crops	- Income from selling seeds to the VEC and food crop in the open market - Microfinance transactions
Village Energy Committee (VEC)	- Decision for power connection and disconnection. - Decision on Electricity tariff - Timing of Electricity distribution	- Electricity Bill collection - Conflict resolution among village level stake holders - Providing salary to equipment operators - Attending to complaints & suggestions on power usage	- Electricity tariff - Lending space of power house as temporary storage of food grains. - Income from rice de-husking - Village fund
Electricity Users	- Access to the energy produced	- Using electricity efficiently	- None from project
Equipment and Lubricant Provider	- None towards the project.	- On time delivery of equipments and lubricant - Monitoring the quality of the oil to the optimum standard.	- Selling of the lubricants and machinery
WII	- Choosing the technology - All financial related matters	- Village Institution building - Community mobilisation - Rural energy planning - Information dissemination & Training,	- Grants from donors

The cultivation of the crop is done on private land and also on road sides. The demand and supply of the seeds is currently unsustainable as the production is not adequate to meet the demand. Therefore increasing production, the area of the plantation and improving management are priorities moving forward.

Self-Help Groups appear to supplement and share the responsibilities of VEC well. The financial aspect is managed by WII. To improve the agricultural productivity, WII has also undertaken soil and moisture conservation activities in the village.

## Analysis of Livelihoods Outcomes

### Financial Capital

The money collected from tariffs and rice de-husking services are deposited in the VEC bank account. This suffices the requirement of money to pay salary for the power plant operators and incidental expenses in maintenance of the power plant. Efforts are going on to use the press cake for briquetting and its safe use in the eateries which would be added income and help to reduce the power tariff. In future, the VEC and the Self Help Groups would be associated with micro finance institutions thus diversifying the income sources. The

initiative brought alternative livelihood options to the village. The village depends on Non Timber Forest Produce like Sal (*Shorea robusta*) and Tendu (*Diospyros melanoxylon*) leaf trading on a large scale. Increase in the duration of light helped to selective grading and packaging of the material thus contributing in their income. Now, the farming community can spend more time in agriculture related work. Increased duration of street lighting helped business in the shops as people can venture out into street at night. WII initiative provides

an opportunity to utilize the available time in efficient manner which leads to increase in income.

#### **Human capital**

The series of trainings and capacity building exercises helped to build local technicians who can maintain and carry out minor repairs in the machinery. Woman folk can finish the house chore like cooking etc. and spent some quality time with family. This also imparted other income generating activities and quality of life improved. The school going children could spend more time reading hence increasing the intellectual capacity. Village meetings are organised regularly and this facilitated dialogue among villagers and possible solution of other issues for village development

#### **Social capital**

The community mobilisation effort put together by Winrock yielded increased awareness among the

## **Overall Conclusion**

The project continues to evolve over time with weaker elements being addressed and improvements made. The saplings require a period of 4 to 5 years time to provide sufficient yield. However the saplings are yet to arrive at maturing stage and therefore the additional seeds are at present procured from the external market. Strategies are being deployed to undertake plantation to ensure constant and sufficient supply and of seeds in future. The likely technical sustainability of the project can be gauged from the fact that to date the operation of the power plant has been totally reliable without even one day of downtime in 18 months (from April 2007 to date) of running. The level of interest and feeling of ownership have been increasing steadily, not only among the VEC members, but also among the community. The villagers now feel the benefits of electricity in their lives and this drives them to work towards sustained management of the initiative.

villagers. The community shows immense interest in the project and there is steady increase in ownership feeling towards the project.

#### **Physical capital**

The project established a power house in the village and transmission lines. The funds generated through the project would lead to establishment of infrastructure in future. Many villagers have now television sets for entertainment and information.

#### **Natural capital**

The soil and moisture conservation works helped to reduce the surface flow and increased periodicity of water availability for Agriculture. Press cake may be used as manure in near future after ruling out possible toxicity to crop thus completing the nutrient cycling.

The project is also working towards briquetting the jatropha press cake and its possible sale as fuel in nearby towns which would help in reducing the electricity tariff. Efforts are also underway to establish small business plans for the VEC and SHG groups which would open additional source of income.

The initiative establishes the idea of rural electrification through active community participation. The promotion of small scale village energy generation helps to boost the village economy by providing alternative livelihood opportunities. It also helps accessing clean and affordable energy source and maintaining the energy security of the rural community.

<b>Initiative Name</b>	<b>Case 9 - Biodiesel based Water pumping program in rural Tribal villages of Orissa</b> Carbon-Neutral Biodiesel-fuelled Energy System (CNBFES) Project
<b>Location</b>	Mohuda, Berhampur, ORISSA, India
<b>Initiation date and Duration</b>	February 2004 and 5 years
<b>Project Initiator</b>	The Gram Vikas- CTxGreEn Biodiesel Project was initiated in February 2004 in Orissa with funding won from the World Bank Development marketplace (DM2003) competition
<b>Overall Budget</b>	US\$ 230,300
<b>Energy output</b>	20 litres of Biodiesel produced that pump 2, 85,000 litres of water per month in a 3.5 HP engine.
<b>Area of Land Under Cultivation</b>	5 Acres
<b>Beneficiaries</b>	52 Households of 3 Tribal villages. , Biodiesel based water pumping program in Tribal households.

## Introduction

Orissa occupies 4.87% of the total geographical area of India. The state occupies an important place in the country having a high concentration of Scheduled Tribe (ST) and Scheduled Caste (SC) populations. These are the groupings of Indian population explicitly recognised by the Constitution of India. Some Scheduled Caste groups are also called Dalits and some Scheduled tribes are Adivasis. Both Scheduled Tribe and Scheduled Caste constitute nearly 38.66% of the total State Population (ST: 22.13% and SC: 16.53% as per 2001 Census). The biodiesel-based water pumping project is being implemented in the remote and tribal belts of two neighbouring Ganjam and Gajapati districts of Orissa. Agriculture is the main source of livelihood in Gajapati district. Gajapati is sparsely populated (120 people per km<sup>2</sup>) and has steep hilly mountainous areas, which are poorly connected and offer a difficult existence for the communities living there. 50% of the population of 0.5 million in Gajapati district are Tribal<sup>1</sup>. The tribal population in Ganjam district is less than 20%. The biodiesel project, a collaborative venture between the Canada based CTxGreEn and Gram Vikas is in the most remote and non-grid villages of Ganjam and Gajapati districts. CTxGreEn is a Canadian team of

technical experts dedicated to promote community based clean and green energy technologies. Gram Vikas is a voluntary organisation that has been working since 1979 to bring about sustainable improvement in the quality of life of poor and marginalised rural communities - mostly in Orissa through Rural Health and

Environment Programme (RHEP) and as a part of Integrated Tribal Development Programme (ITDP). Part of their mission is the provision of safe drinking water and sanitation, creation of adequate rural infrastructure and capacitating the natural as well as human resources for secure livelihoods. Gram Vikas initiated biodiesel based water pumping primarily for sanitation in 4 villages, and later on extended into critical irrigation of crops. The Mohuda pilot plant and training Center was established in May-June 2004. A biodiesel production unit was installed in Kinchlingi in November 2004 in Gajapati district. The second initiative took shape in the twin villages of Kandhabanta-Talataila of Ganjam in December 2004 and the third in Tumba of Gajapati district.

## The Initiative Market Map

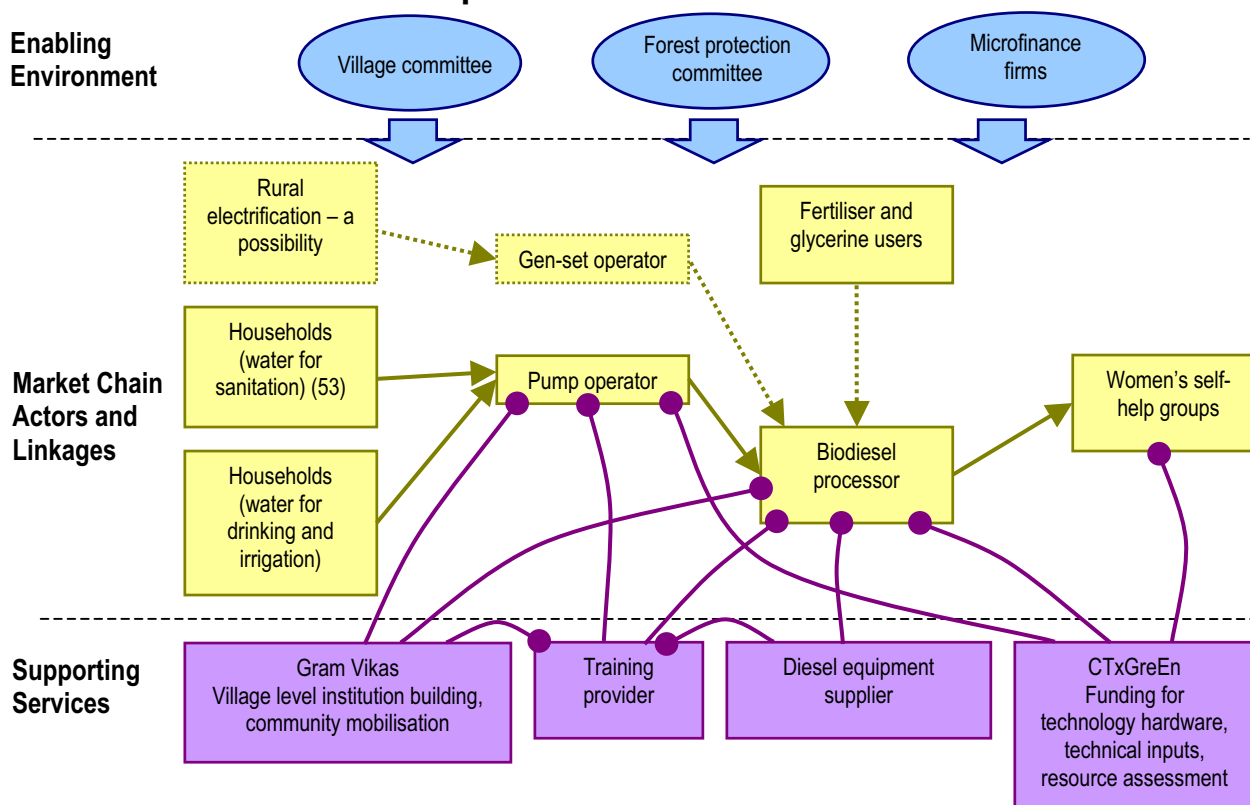

The objective of the initiative was to provide water and sanitation services through a bio-energy system that eventually led to regeneration of land resources and improved livelihood opportunities. Most of the project villages belong to the Sauras, an indigenous shifting agriculture (locally called Bogodo) dependent community. Most of the villagers are marginal farmers with land holding ranging from 0.5 to 2 Acres. Villagers, mostly women, had been walked long distances and spend many hours to hand-pump household water each day. The present initiative is small-scale, biodiesel-fuelled equipments that allowed electricity production for water pumping and lighting. The biodiesel production unit uses the local underutilised seeds of *Pongamia pinñata*, *Madhuca indica* from Forest and *Guizotia abyssinica* (Niger) as feedstock. Alcohol (Methanol or Ethanol) and Lye (Sodium or Potassium Hydroxide) are used to convert vegetable seeds to biodiesel. These reagents are purchased in the open market. Niger is an indigenous oil seed crop widely adapted to varied soil conditions. It is commonly grown in India on poor soils or infertile hilly slopes. Villagers cultivate the community and fallow lands in and around the village to grow Niger seeds. Afterwards Agricultural bunds and kitchen gardens are also brought under plantation to supply adequate oil seed.

The significant aspect of the project is the use of non-edible oil to produce biodiesel in decentralised manner catering the energy need of rural poor people without affecting food production. It also discourages large-scale monoculture and endorses a stronger village economy. Biodiesel is produced through the process of transesterification in a pedal powered reactor. The machines installed are for grinding oil seeds, pressing oil from seeds and getting biodiesel from the oil. Recently a Mafuta Mali Oil press from Kenya was included in the biodiesel technology package with minor adaptations to suit the range of Indian seeds. The press is hand operated while the grinder and biodiesel reactors are pedal operated. The local community uses the by-products, such as pressed oil cake and glycerine, as natural fertilizers and cattle/poultry feed. Biodiesel, thus produced can be stored easily and used as and when required in the regular pump or generator sets. The machinery set up runs by the volunteering method in the form of Sweat Equity (Sweat equity is the term assigned for the monetary value of labour work contributed and is equivalent to the opportunity cost). Each household provides a volunteer every month to run the unit. A base amount is fixed for each household for contribution to biodiesel production, production and collection of feedstock and chemicals as sweat equity. This method was developed as the community has

limited liquidity to pay tariff for water. On a bi-monthly or weekly basis the reactor produces five litres to 20 litres of fuel in batches consuming 20kg and 80kg

seeds/batch respectively. Kinchlingi village needs 11-13 litres of Biodiesel every month, which can be produced in 2-3 batches.

## Relationships between Market Actors

	Equipment Supplier	Biodiesel Processors	Pump Operators	Microfinance Firms	Woman Self Help Groups	Forest Protection committee	Gram Vikas/ CTXGreen
Equipment Supplier							
Biodiesel Processors							
Pump Operators	Good Formal	Good Formal					
Microfinance firms	Good Formal	Financial	Financial				
Woman Self Help Groups	Formal	Good Formal	Good Financial	Good Formal			
Forest Protection Committee	Good Informal	Good Informal	Good Informal	Good Informal			
Gram Vikas/CTXGreen	Good Technical Formal	Good Technical Formal	Good Technical Formal	Good Financial	Good Technical Formal	Good Formal	

Women's self help groups act as savings and credit organisations, with support from microfinance firms, which generate additional income. The self-help groups are trained to play an active roll in all aspects of seed collection, processing and fuel use. A core team of staff members was created to support the operational training at village level and to train the maintenance personnel. The demonstration and laboratory unit of Gram Vikas functions as the nucleus of Training and capacity building. Biodiesel recipes have been developed at the Mohuda pilot plant for Niger (*Abyssinca guizotia*) and Mahua (*Madhuca indica*), and training programmes are ongoing for dissemination to

the village units. Work continues on standardising these recipes and developing others for Karanja (*Pongamia pinnata*), Kusuma (*Schleichira oleosa*), castor (*Ricinus communis*), Neem (*Azadirachta indica*) and local varieties of Jatropha. The laboratory established at Mohuda carries out regular evaluation of the biodiesel produced in the village to ensure world biodiesel standards.

CTxGreEn anchors the funding for the technology hardware, and also for the resource assessment part where as Gram Vikas takes care of the institutional fostering and community mobilisation aspect.

## Balance of Rights, Responsibilities and Revenues of Market Actors

Actors' 3Rs'	Rights	Responsibilities	Revenues
Forest Protection committee	<ul style="list-style-type: none"> <li>- Forest usage rights through Forest Protection committee.</li> <li>- Legislate on forest usage and development</li> </ul>	<ul style="list-style-type: none"> <li>- Protection of the forest resources from Fire, Illicit cutting and poaching.</li> </ul>	<ul style="list-style-type: none"> <li>- Subsistence from the selling of Non Timber Forest Products.</li> <li>-</li> </ul>
Village Committee	<ul style="list-style-type: none"> <li>- Decision making in resource management.</li> </ul>	<ul style="list-style-type: none"> <li>- Formulating Regulations for water supply and sanitation.</li> <li>- Monitoring and Evaluation of the project processes.</li> </ul>	<ul style="list-style-type: none"> <li>- Village funds from RHEP.</li> <li>- Tariff from Electricity usage and Water services.</li> <li>- Project contributions from funding agencies.</li> </ul>
Biodiesel Processors	<ul style="list-style-type: none"> <li>- Ensured supply of oil seeds.</li> </ul>	<ul style="list-style-type: none"> <li>- Equipment up keeping,</li> </ul>	<ul style="list-style-type: none"> <li>- Income from the sell of oil cake and Glycerin.</li> </ul>
Pump Operators	<ul style="list-style-type: none"> <li>- Right to the vegetable oil.</li> </ul>	<ul style="list-style-type: none"> <li>-Maintenance of the equipment.</li> </ul>	<ul style="list-style-type: none"> <li>- Subsistence from the operation.</li> </ul>
Microfinance Firms	<ul style="list-style-type: none"> <li>- Right to take appropriate actions under deferred repayments and similar other conditions.</li> <li>- Right in taking decision to fund a group or not.</li> </ul>	<ul style="list-style-type: none"> <li>- Providing the finance in time for the purchase of Alcohol, wash room construction and seeds purchase</li> </ul>	<ul style="list-style-type: none"> <li>- Financial relationship with Self help groups,</li> </ul>
Woman Self Help Groups	<ul style="list-style-type: none"> <li>- Right to the water and other by products.</li> <li>- Equal involvement in the decision making process.</li> </ul>	<ul style="list-style-type: none"> <li>- Procurement and Collection of oil Seeds</li> <li>- Cultivation of Niger seeds</li> <li>- Construction of the wash rooms and its maintenance</li> <li>- "Caretakers" of the land and natural resources.</li> </ul>	<ul style="list-style-type: none"> <li>- Savings and credits from the initiative.</li> <li>- Income from farm products</li> </ul>
Gram Vikas/ CTxGreEn	<ul style="list-style-type: none"> <li>- Formulating strategies as per the need during project implementation</li> <li>- Access to the Village energy committee registers, log books and project accounts.</li> <li>- Decision on the fiscal matters.</li> </ul>	<ul style="list-style-type: none"> <li>- Village level Institution building</li> <li>- Community mobilisation</li> <li>- Rural energy planning by survey, Forest Survey with the Community Forest Management group.</li> <li>- Information Dissemination, Training</li> <li>-Funding for the Technology hardware.</li> <li>-Technical inputs, Resource Assessment.</li> <li>- Setting up baseline on the target species that can be used as biodiesel feed stock.</li> <li>-Livelihood Analysis, Monitoring at watershed level</li> <li>-Promoting small scale enterprises on the byproducts like Glycerin for soap making</li> </ul>	<ul style="list-style-type: none"> <li>- None from the Project.</li> </ul>

Use of methanol and ethanol in the production of biodiesel attracts the excise law that forbids any activity dealing with intoxicants under the legal and regulatory framework. The excise laws *per se* do not recognize the production of

biodiesel from the perspective of alcohol. The use of absolute alcohol or rectified spirit (RS) / denaturated spirit (DS) in the production of biodiesel for the bona fide consumption of tribal village community in Scheduled areas is emerging as a policy imperative<sup>6</sup>.

The raw material used is sourced from the forest. Access and use of Non Timber Forest Products (NTFP) used are subjected to the influence of The Orissa Timber and Other Forest Produce Rules, 1980, State Policy Resolution of Government of Orissa, Forest and Environment Department and Orissa Gram Panchayats (Minor Forest Produce Administration) Rules 2002<sup>7</sup>. The current policy environment is favourable for the

initiative. Around 68 forest species have been deregulated and hence are exempted from Transit permit requirements. But the state reserves the power to alter the list of regulated forest species. This is a critical concern for the forest produce based rural energy set up. So it is imperative to seek a formal notification from the state government ensuring protection from such state of affairs.

## Analysis of Livelihoods Outcomes

Nutrient recycling is complete as the locally grown crop seeds and oil cake as green manure.

**Human capital:** The project prepared well trained rural bare-foot technicians capable of handling and maintaining the equipments. Knowledge transfer to improve the Niger yield and procurement and collection of healthy forest seeds were also carried out.

**Natural capital:** Water availability through irrigation supports improved agricultural productivity. Slash and burn agriculture (Bogodo) is being substituted by multi crop organic agronomic practices. A seed bank has been established to preserve precious germplasm and enabling sharing of local knowledge among villagers.

**Social capital:** The community mobilisation work yielded dividends in terms of a work force that made the project work successfully. Establishment of Village committees and women-centred self-help groups brought much needed self sustainability strength. Cross-learning and knowledge exchanges helped in sharing and documenting of tribal experiences on seed/fruit collection, storage, and processing of seeds.

**Physical capital:** The biodiesel pump set and gen-set have been commissioned and installed in the village. The full operational water tank in every project village becomes the testament of successful convergence of a simple eco-friendly technique with community participation.

### Financial capital:

Biodiesel from non-edible oil seeds when implemented in decentralised manner leads to stronger village level economies. It minimizes cash out flow and creates more jobs in the neighbourhood. Optimum use of land and water resources ensures food and fuel production in tandem without disturbing the ecosystem linkages. Micro finance linkages to the project strengthened financial affairs and might be a lucrative option for green investors and Carbon Trading.

CTxGreEn foresees potential in producing alcohol (Methanol/Ethanol) locally using underutilised fruits through the up gradation of traditional tribal alcohol manufacturing technique that will make the initiative cost effective.

## Overall Conclusions

For the villager, the best technology is one that produces the fuel easily, which is stored for use as and when required, has the lowest capital investment, maximizes local value addition, minimizes cash outflow from the village economy and restores the natural resources sustainably<sup>7</sup>. This project has many implications that extends into wide-scale rural electrification, biodiesel-fuelled gen-sets, farm tools, battery-banks and battery-powered LED lighting. Promotion of micro-enterprises for making glycerine based soap is a near fulfilled target. There are several challenges that delimit large-scale implementation. Fragile village level institutions, vested political interest, the absence of strong local level governance (like Panchayat) are some of institutional challenges. Existing complex legal enforcement in accessing Non

Timber Forest Products and excise laws debar promotion of village level energy generation. There is a paradigm shift necessary in the state policy to enable and encourage such small scale energy vis-à-vis livelihood self sufficiency initiatives. Land tenure rights are poorly established in the backdrop of fragmented communal land holdings. Often distress selling of oil seeds for instant cash is observed among poverty stricken tribal people, and the influence of money lenders cannot be ruled out. The local oil mills are in direct competition for the raw materials. The project has established the technical feasibility, promises sustainability and also reiterated that when used as a community tool for productive livelihoods, there will be enough fuel in addition to sufficient food.

<b>Initiative Name</b>	<b>Case 10 - Sri Lanka Spice Drying</b> <i>Bio-energy dryer for spice drying in rural Sri Lanka</i>
<b>Location</b>	<i>Kandy, Sri Lanka, South Asia Region</i>
<b>Initiation Date and Duration</b>	<i>2005 to date</i>
<b>Funder(s)</b>	<i>National Agribusiness Council, UNDP/GEF, USAID, Regional Economic Advancement Project, Matale</i>
<b>Project Initiator</b>	<i>Alliance for Appropriate Technology Exchange (AfATE), Kandy</i>
<b>Overall Budget</b>	<i>\$5,460 received from UNDP and National Agribusiness Council,</i>
<b>Output</b>	<i>Depending on the size, the burner consumes 4 -8 kg of wood pieces per hour producing 15-33kW of heat. Dryers come in 3 different sizes, with the capacities to dry 220kg – 400 kg of green pepper in one batch during 12 -18 hrs.</i>
<b>Area of Land</b>	<i>Not applicable</i>
<b>Beneficiaries</b>	<i>A total of 19 dryers are in operation and 5 more are under construction. These dryers are mostly being used by spice growers in Kandy district. The Small Spice Growers Association was formed by the dryer users (mainly 5) and has 52 members in clusters and additional 25 farmers also bring their spice to the society.</i>

## Background and Context

Nestling off the southern tip of India, Sri Lanka is home to around 20 million people and boast the highest per capita income in South Asia (\$4,264). For nearly two decades, the island was scarred by a bitter civil war arising out of ethnic tensions. A ceasefire was signed in 2002, but it was undermined by regular clashes between government troops and Tamil rebels, and in January 2008 it expired.

The Government of Sri Lanka's Energy Policy outlines specific targets and milestones for developing and managing the energy sector in the country. Specifically, new initiatives are included to expand the delivery of affordable energy services to a larger share of the population, to improve energy sector planning, management and regulation, and to establish biomass as a significant source of commercial energy.

Occupying an important place in the path of major sea routes, Sri Lanka is one of the world's leading producers and exporters of spices. While the country's most prominent export might be tea, historically the most important has been spices such as Cloves, Cardamom, Pepper, Nutmeg, Mace, Ginger and Cinnamon which have been grown, processed and exported on a large scale dating back to antiquity. Spice processing is a fine art of preserving the product

while keeping its aroma and colour intact. Spices have to be dried at suitable conditions to avoid fungi attacks and mixing with impurities. Moreover, the quality of dried spices is a vital factor in the export market. The Department of Export Agriculture speculates that the stringent quality requirements would harm Sri Lanka's export potential drastically in the future if current practices of spice production are not improved. Application of proper drying technologies is key to this improvement but has yet to be achieved. This is not down to a lack of technologies per se, but because of a mismatch with the needs and requirements of the majority of farmers. The prices, capacities, and operation costs of existing dryers (such as oil or gas fired dryers) do not match the production volumes or the affordability of farmers.

In order to address the need for an appropriate spice dryer for rural communities in Sri Lanka, the Alliance for Appropriate Technology Exchange (AfATE) developed and patented an innovative wood-fired dryer in 2005/06. This has been constructed after a year of research and development work undertaken by the AfATE and University of Ruhuna with financial support from the UNDP and National Agribusiness Council. It has since been distributed as a commercial dryer, popular among medium to large scale spice producers and enterprises.



## The Initiative Market Map

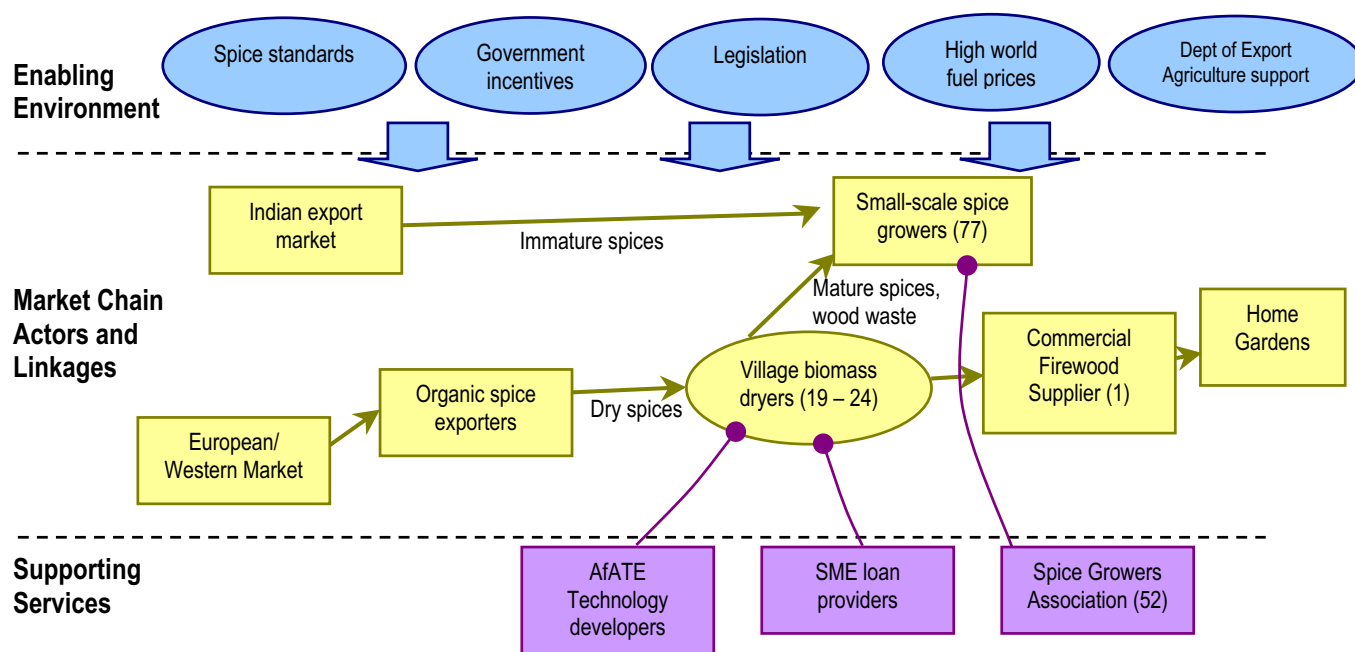

With the introduction of the biomass dryer by AfATE to village-level dryer operators, an opportunity for small-scale spice growers to diversify their client base and obtain higher prices for their products has been created. Previously, small scale growers were only selling immature spices direct to the Indian export market for quick income. Immature spices are picked from the plant early on, can be cultivated much more quickly but achieve a lower market price for the growers. Immature spices are used for resin extraction and exported to India. As spice growing areas are located in wet zones prone to intermittent rains, the final product is usually of low quality. Growers are therefore unable to fetch high prices or access more lucrative markets. Mature spices which require a longer growing period and drying can fetch premium prices on the European and Western export markets. The biomass dryer helps growers and processors to achieve this objective. Spice growers sell mature spices direct to village dryer operators who then dry and sell on the spices to European and Western markets via spice export companies. A total of 19 dryers are in operation and 5 more are under construction. These dryers are mostly being used by spice growers in Kandy district.

One of the main advantages of the wood-burning AfATE dryer is the availability of processed firewood

locally. There is one commercial supplier in the area who was supplying cut and dried *Gliricidia* to a grid connected dendro power plant with a capacity of 1MW in the Central province- the only power plant of its kind in the country. The commercial supplier buys *Gliricidia* sticks from home growers, cuts and dries the sticks and then sells them on to the power plant. However, the power plant has been out of operation in recent times and the commercial supplier and small scale growers have lost income. The AfATE biomass dryers have now re-invigorated this supply chain. The commercial fire wood supplier has linked up with a Spice Growers Association, buying from home garden growers and is supplying fuel wood to village biomass dryers. The commercial supplier now has two casual employees to help meet increased workload.

It is interesting to note that fuel wood can be grown alongside pepper. Pepper is grown on a tree (usually on *Gliricidia*) and the branches of the support tree are pruned after harvesting. If not used for any productive use, these branches create extra burden for farmers, as they have to use paid labour to remove them from the plantation. Now, however, spice growers can sell these branches as fuel wood to biomass dryer operators and obtain additional financial income.

## Relationships between Market Actors

	Small-scale spice growers	Commercial firewood supplier	Village biomass dryer operators	Home gardens	AfATE	Spice Growers Association
Small-scale spice growers						
Commercial firewood supplier	None					
Village biomass dryer operators	<b>Good</b> - informal, financial	<b>Average</b> - informal, financial				
Home gardens	None	<b>Good</b> - informal, financial	None			
AfATE	None	None	<b>Good</b> - informal, technical and financial	None		
Spice Growers Association	<b>Good</b> - informal, organisational	<b>Good</b> - informal	<b>Good</b> - financial	None	None	

The small scale spice growers have an informal relationship with the biomass dryer operators to whom they sell both spices and fuelwood.

The relationship between the commercial firewood seller and the village biomass dryer operators is not formal, but satisfactory and improving. Even though drier operators have the option of collecting firewood from their own plantations and through the small scale spice suppliers, the operators prefer the convenience of directly sourcing processed firewood ready to use. Furthermore, given that firewood requires a large amount of storage space and protection from insect attacks (termites etc.), biomass dryer operators are now proposing arrangements for the firewood supplier to store products on their behalf and deliver as required to the various dryer locations. Though this arrangement is not in operation at the moment, at least one dryer operator is very interested in this arrangement. The relationship between AfATE and the dryer operators is strong though it is not formal. Frequent visits by AfATE to monitor the machinery and providing technical help as necessary has developed confidence among users and has helped in generating more sales.

Further, close and continuous monitoring has helped AfATE to design dryers of better quality and performance and to make them more user friendly.

AfATE does not provide any financial assistance to the buyers. Department of Export Agriculture provides financial assistance up to Rs. 100,000, depending on the capacity of the dryer, to the buyers to purchase (or recover the cost if the dryers are already purchased) the dryers. About 4 of them have already received this assistance, while several others have made applications. The buyers also approach banks or other financial institutions on their own. The higher prices the drier operators get for quality spices helps them to meet their financial obligations towards purchasing the dryer.

The spice growers association, pays the small producers a higher price when they purchase raw spices from small producers. The raw spices purchased from the small producers are dried using the dryer and the is sent to export market by the spice growers association.

## Balance of Rights, Responsibilities and Revenues of Market Actors

Actors/ 3 R's	Rights	Responsibilities	Revenues
Small scale spice growers	<ul style="list-style-type: none"> <li>- Grow spices</li> <li>- Land rights (they own the lands)</li> </ul>	<ul style="list-style-type: none"> <li>- Sell quality raw spices to dryer operators</li> </ul>	<ul style="list-style-type: none"> <li>- Sales of spices to biomass dryer operators and the Indian export market</li> </ul>
Commercial firewood seller	<ul style="list-style-type: none"> <li>- Collecting firewood from the village</li> <li>- Chipping and drying of firewood</li> <li>- Selling firewood chips</li> </ul>	<ul style="list-style-type: none"> <li>- Provide quality firewood on time at an affordable price</li> </ul>	<ul style="list-style-type: none"> <li>- Income from selling firewood chips</li> </ul>
Village biomass dryers	<ul style="list-style-type: none"> <li>- Drying spices for farmers</li> </ul>	<ul style="list-style-type: none"> <li>- Maintain the quality of final products</li> </ul>	<ul style="list-style-type: none"> <li>- Service charges from farmers</li> </ul>
AfATE	<ul style="list-style-type: none"> <li>- Manufacturing dryers</li> </ul>	<ul style="list-style-type: none"> <li>- Making the dryer cost effective</li> </ul>	<ul style="list-style-type: none"> <li>- Selling dryers to village dryer operators</li> </ul>
Home gardens	<ul style="list-style-type: none"> <li>- Collecting firewood from their gardens</li> </ul>	<ul style="list-style-type: none"> <li>- Collect firewood from villagers on pre-agreed dates on agreed price</li> </ul>	<ul style="list-style-type: none"> <li>- Income from firewood sales</li> </ul>
Spice Growers Association	<ul style="list-style-type: none"> <li>- Organize spice chain actors</li> </ul>	<ul style="list-style-type: none"> <li>- Lobbying for issues related to sector</li> <li>- Looking for better markets</li> </ul>	<ul style="list-style-type: none"> <li>- Membership fees</li> </ul>
Department of Export Agriculture	<ul style="list-style-type: none"> <li>- Limited regulation of export by sector</li> </ul>	<ul style="list-style-type: none"> <li>- Promote spice products to export markets</li> </ul>	<ul style="list-style-type: none"> <li>- Central Government funds</li> </ul>

The Spice Growers Association has been a key player in promoting the quality of spices and assisting members to look for better markets. The Association was formed by the dryer users and has 52 members in clusters. An additional 25 farmers also bring their spice to the society. As a group, spice growers have increased bargaining power when approaching financial institutions to access credit facilities. This way, financial barriers presently encountered by individual processors in acquiring equipment are somewhat mitigated.

The Department of Export Agriculture plays an important role in promoting products in the export market but it does not have all the regulatory powers necessary to regulate the industry. Distortions are created in the market by certain traders paying high prices for immature pepper. Therefore, farmers tend to sell the produce early for quick cash, without waiting for

another few weeks for spices to mature when they would fetch a higher price.

The firewood supplier buys *Gliricidia* sticks from the growers at \$0.0091 per kg cut at their home gardens with approximately 60% moisture content or at \$0.0136 per kg at the supplier's property. Dried and cut fuel wood (of 18-20% moisture) is sold at \$0.05 per kg. The supplier uses a small machine to cut the sticks to the desired size (3 -4 inches, or 3 feet sticks), but does not use any other energy source to dry them. After cutting into pieces the sticks are left in a covered area to avoid getting wet due to rain and allowed to dry naturally. At present, the commercial fuelwood supplier is able to sell all the fuelwood he can obtain.

AfATE does not play a significant role in initiation of the fuel wood supplier's business, but whenever the dryer users seek assistance from AfATE the organisation directs them to the fuel wood supplier. AfATE is an NGO.

## Analysis of Livelihoods Outcomes

In terms of **human capital**, biomass dryer operators now have knowledge of and access to a new technology which is fuel efficient and lowers costs of production. This new technology is subject to further research and development thanks to AfATE's engagement with dryer operators. Demand for dryers are now coming in from other similar industries.

The Spice Growers Association is the key **social capital**. The biomass dryer has improved the reputation of the Association as a good quality producer among European markets.

The dryer is the most important additional **physical capital** this project has brought to the small scale growers as it enables them to process their produce in a shorter time period than the conventional way, ensuring better quality, also reduce wastage. Since no

fossil fuel is used for drying in this way, the dryer is environmentally friendly.

The use of abundantly available fuel wood without risk of deforestation to forests and improved combustion helps to preserve **natural capital**. Since spice and fuel wood plantations can go hand in hand, this is a sustainable way of ensuring quality drying. Since there is always an excess of *Gliricidia* production in spice gardens, sustainable harvesting can be ensured.

**Financial Capital** has been increased for all actors in the market chain through improved product quality, as well as increased sales volume. The amount of cash handled by the spice growers and dryer users (they are also growers) has also increased with the usage of dryers.

## Overall Conclusions

The AfATE biomass dryer helps small scale farmers to produce higher quality products and access important export markets attracting better prices and increasing financial assets. A chain of firewood supply has been created with the introduction of this intervention. Spice growers are now able to earn additional income from fuel wood grown alongside the spices.

The main successes of this intervention are the close association of the biomass dryer manufacturer (AfATE) with the users of dryers. This has led to improved technology and maintained dryer operators' confidence in the machinery. Furthermore, the emergence of the Spice Growers Association has enabled a collective approach to the sector specific issues at a local level.

Market distortions in the spice market by directing produce to other uses and lack of proper guidance and

pricing mechanism in the fuel wood chain are the aspects to be considered for further expansion.

Escalating prices of raw materials for dryer manufacturing (e.g. stainless steel) affect also the affordability of the dryer by the small and medium scale operators/farmers.

Though the firewood is available in abundance, collection and processing involve costs and must provide clear profit margins in order to keep actors motivated. At the same time, pricing cannot be unreasonably high so as to negatively affect processing cost of spices. Therefore, a clear pricing mechanism for fuel wood is required to help safeguard the interests of all stakeholders.

<b>Initiative Name</b>	<b>Case 11 - Brazil Ethanol Micro-distilleries</b> <i>PROJECT GAIA BRAZIL - "A model for a community-owned and -operated microdistillery to fuel cooking stoves in rural areas"</i>
<b>Location</b>	<i>Minas Gerais State, Brazil</i>
<b>Initiation Date and Duration</b>	<i>Test of fuels: October 2005 to June 2007</i> <i>Viability Microdistillery Study: July 2007 to December 2008</i>
<b>Funders</b>	<i>Shell Foundation and Dometic AB</i>
<b>Project Initiator</b>	<i>Project Gaia</i>
<b>Overall Budget</b>	<i>US\$122.390,26</i>
<b>Energy Output</b>	<i>21,600 litres ethanol/year</i>
<b>Area of Land</b>	<i>7.5 hectares for ethanol, 1 hectare for "rapaduras"</i>
<b>Beneficiaries</b>	<i>90 families, users of CleanCook stoves</i>

## Background and Context

Project Gaia is part of a global initiative created to promote the use of clean-cooking fuels, using ethanol, aimed at the poorest part of the population. In Brazil, the project aimed to evaluate the acceptance of clean-cooking fuels by domestic users in different urban and rural areas. The project also evaluated practicality, safety and economy.

Brazil has some of the most extensive experience in biofuels worldwide, owing to its National Alcohol Fuels Research Program (PROÁLCOOL) created to stimulate the production of alcohol fuels and reduce dependence on oil derivatives, and also thanks to research programmes run by automobile companies and the sugar industry.

The technology for large scale production of ethanol and the knowledge of small scale production, together with food production (alcohol and milk), attracted the attention of Project Gaia. In spite of the logistics and infrastructure constructed to facilitate access to Liquefied Petroleum Gas (LPG) – known as cooking gas – many rural communities, mainly in the north and north-east of Brazil, do not have access to LPG and continue using firewood as their main source of fuel. A key factor is the price per cylinder of LPG. From the creation of the Real Plan in 1994 (the government economic stability plan) Brazil had an accumulated inflation of 225.25% and an increase in the price of a 13kg cylinder of LPG of 639.51%. This contributed to the increase in the number of families returning to use firewood as their main source of fuel, reaching 38% in the first quarter of 2007.

The State of Minas Gerais was chosen for this project because of its historical use of firewood for boiling

and for producing cachaça – a typical drink made from the fermentation of sugar cane with a 20% production waste. This waste occurs because, during the fermentation process there may be some kind of contamination, and also during the distillation due to the use of copper alembic stills. The resulting co-products can be harmful for human health, so it is common to separate the liquid that is obtained at the beginning and at the end of the distillation process.

In order to assess the acceptability of the CleanCook stove, communities with different profiles were selected, and fuel was supplied at an accessible price. This was necessary because of the high price of ethanol in fuel shops. Local partnerships were also considered. Three communities from the Minas Gerais State were selected: Salinas, in the north of the State, Uruçania, in the central region (in partnership with the Jaticoba Mill that provided ethanol to families in rural areas), and Betim, in the metropolitan area of the state capital, in the Dom Orione settlement.

During the stove testing phase, until June 2007, Project Gaia received funding from the Shell Foundation and Dometic AB of Sweden, which donated the stoves. Today, Project Gaia uses its own resources, and has reached the dissemination of results phase, spreading information about the tests of the CleanCook stove in order to educate the market to sell stoves to the public.

Project Gaia Brazil began to study the technology and the feasibility of micro distilleries of ethanol (MDE) in order to promote access to low cost fuel, in addition to promoting the development of communities. Studies

were based on existing micro distilleries, and Gaia are working on the implementation of a MDE in the Dom Oriane settlement. There are 39 families at the settlement, most produce vegetables, and a small group works on the production of derivatives of sugar

cane, and know the ethanol production process from MDE. All families have shown interest in the production of ethanol and can provide a small area for planting sugar cane.

## The Initiative Market Map

It is important to mention that in the initial phase of tests of the CleanCook stove, Project Gaia donated the ethanol to the families, (with the exception of Uruçania, where ethanol was donated by a sugar and alcohol plant). The price increased progressively until market price was reached, evaluating the buying and selling capacity of the families. Project Gaia was in

charge of the distribution of ethanol. Due to the high price of ethanol, many families used the stoves less and this was crucial for the development of market research studies for MDE. The model shown is in development for the settlement Don Oriane in Betim, based on research in a micro distillery unit and also from other studies of Project Gaia.

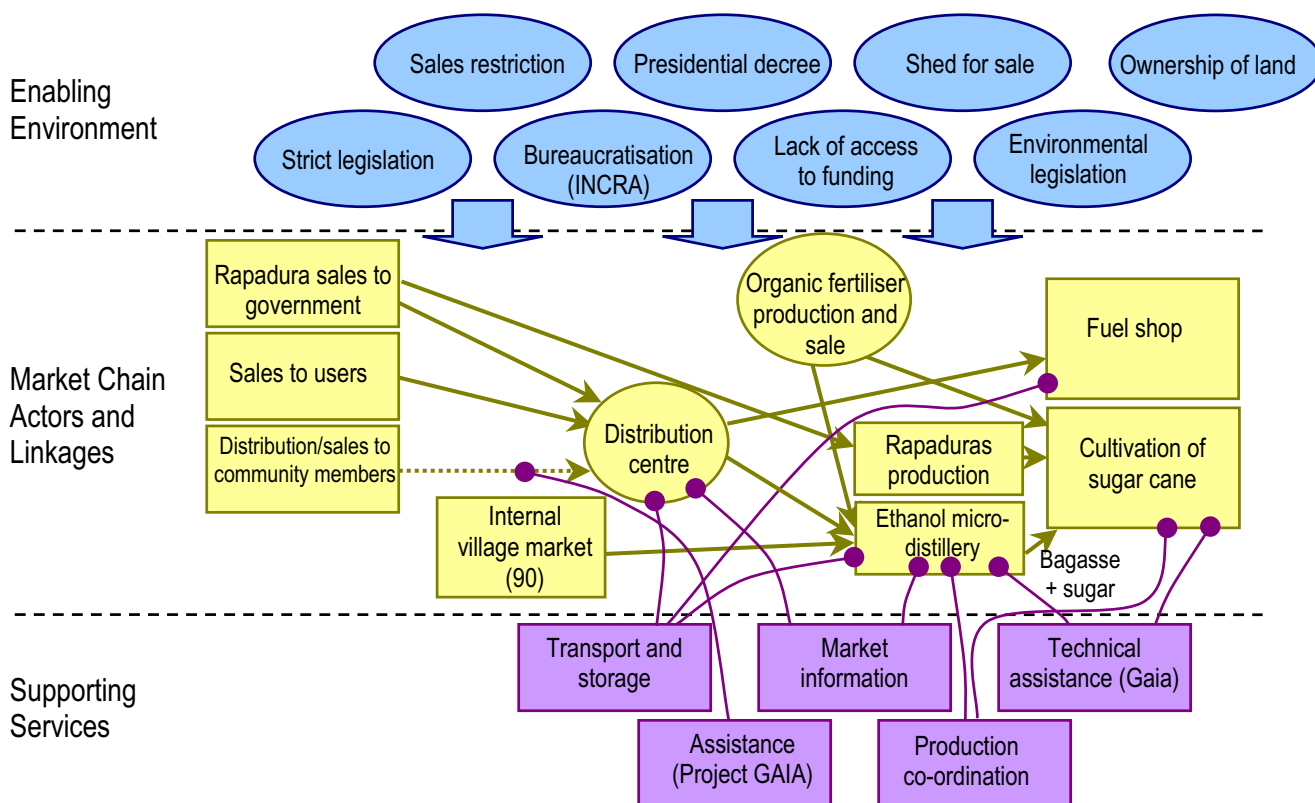

During the tests with the CleanCook stove, Project Gaia created an ethanol distribution centre. The ethanol was purchased by Project Gaia at the fuel shop (initially, ethanol was purchased at gas stations) and transported to the distribution centre, where it was passed on to families. Families were visited by Project Gaia weekly in order to find out whether they were adapting well to the stove and the fuel, and to determine the benefits for these families.

As for the production of rapadura (a sweet solid product, obtained from the concentration of sugar cane, with high levels of vitamins and minerals), this activity already existed at the settlement Dom Oriane

in Betim, and Project Gaia offered support to improve the storage and coordinate the planting of sugar cane in order not to interfere with the future production of ethanol (Currently, Project Gaia has about 5 hectares of sugarcane plantations and the new plant will start production in February. 80 hectares of sugar cane can be planted without harming other crops). The rapaduras currently produced are sold to the local government in a program called "Direct Buy" and are donated to local nurseries, to be served as a food supplement for children up to 6 years of age. Considering the production of ethanol, Gaia have projected to provide technical assistance to EMATER

- Technical Assistance and Rural Extension Company of the State of Minas Gerais – in the cultivation of sugar cane. Project Gaia will assist in the production

of ethanol and help in the coordination of MDE, until they are able to manage the business, from production to final sale.

## Relationships between Market Actors

	Stove Users	Posto Combustible	Local Government	Community Members	Ethanol Producers	EMATER	INCRA	Project Gaia
Stove Users								
Posto Combustible	Good Formal							
Local Government	None	None						
Community Members	Good Informal	Good Formal	Fair - formal					
Ethanol Producers	Good contractual	Good Formal	Fair - formal	Good Informal				
EMATER	None	None	Good Contractual	Good Contractual	Good Contractual			
INCRA	None	None	Fair - formal	Fair - contractual	Fair - formal	Good Formal		
Project Gaia	Good Contractual	Good Contractual	Good Formal	Good - Formal	Good Contractual	Good Informal	Fair - formal	

During the testing phase of the CleanCook stove, Project Gaia was in charge of all intermediation of the purchase and sale of ethanol at the fuel shop. Stove users seek ethanol at the local distribution centre, coordinated by Project Gaia. The local government's involvement with the project was to put Project Gaia in touch with the communities.

During the implementation phase, the MDE will be installed in an area of common use of the 39 families of the settlement. Currently, most families produce vegetables but have an area for the cultivation of sugar cane. From these, 15% are directly involved in the production of rapaduras, and will be responsible for the production of ethanol, as they are already familiar with the process, and 33% are already planting sugar cane. In addition to the 39 families from this settlement, other families from the area will also receive a CleanCook stove unit, and will have access to purchase ethanol at a reduced price, with a monthly limitation. These families will have a contract with Project Gaia and will be registered in the MDE. As the market for stoves grows in the area, other families will be included in the project through contracts and registration in the MDE. In this set-up the local government will be more closely involved, because this institution is accredited to provide environmental licensing for MDE. They could also

provide information on families who have no access to energy, so that they receive the stoves. The Institute of Colonisation and Agrarian Reform (INCRA) will monitor the program as it is the federal agency responsible for settlements, and in spite of being very bureaucratic, it has an interest in the generation of income in the settlements. The Technical Assistance and Rural Extension Company of the State of Minas Gerais (EMATER) is a State Government organisation with an office in the municipality that attends to local demands, offering technical assistance free of charge to small farmers. Project Gaia will facilitate these partnerships in a way that improves relationships and provides information in order to facilitate access to the bioenergy market for other groups of farmers.

Regarding legislation, currently there is only one Presidential Decree from 1981 that authorizes ethanol production in MDE, for vehicular use, but only for the use of co-operative members or associates. In the case of ethanol for domestic use, there is no impediment in sales, but there is also no law regulating the sale. The lack of specific legislation for MDE prevents access to funding, mainly due to restriction of sales, which prevents the creation of a market.

## Balance of Rights, Responsibilities and Revenues of Market Actors

Actors' 3Rs'	Rights	Responsibilities	Revenues
<b>Stove Users</b>	- Buy ethanol at affordable price	- Proper use of ethanol and stoves	- Buy fuel in small quantities - Savings in fuel purchase - Savings in expenditures, benefitting home income
<b>Community Members</b>	- Possession of land - Right to cultivate - Access to low cost fuel	- Protection of natural resources - Supply sugar cane	- Income of agricultural products - Savings in the acquisition of organic fertilizers - Income from sugar cane
<b>Ethanol Producers</b>	- Utilisation of venue and equipment. - Waste utilisation	- Production of ethanol - Follow safety procedures - Participation in trainings	- Rapaduras sale - Ethanol sale - Sale of derivatives
<b>Local Government</b>	- Information on natural resources preservation	- Environmental licence and permits - To buy Rapaduras	- Taxes from the sale of Rapaduras - Economy with direct sale projects
<b>Federal Government</b>	- Formulation of specific policies	- To facilitate access to markets for small producers	- Taxes - Savings in health expenditures due to a decrease in domestic pollution
<b>EMATER</b>	- Orientation on sugar cane production and rapaduras	- Offer technical assistance without cost	- Dissemination of the project in other regions of Brazil
<b>INCRA</b>	- To guide and supervise use of land	- Guide on access to financial resources - Facilitate legal possession of land	- (Indirect) lowering resources from Agricultural Reform (if families have a higher income, the federal government through the INCRA will be able to reduce the resources needed for these families)
<b>Project Members (Project Gaia and USI)</b>	- Orientation on ethanol production - Distribution of stoves	- Assistance in ethanol production - Open market assistance - Project experience dissemination	- Donor and project funds

The project has brought benefits to families who are stove users, initially for the possibility of using a clean technology, and thus avoiding spending on health problems resulting from domestic air pollution. An attractive aspect for families is the ability to buy ethanol in small quantities (compared to the choice of 13 or 45 kg of LPG), since many of the families have no fixed income. It is also important to consider the direct purchase of MDE at a more affordable price. As for the families of the settlement, they are the owners of the land, and therefore have the autonomy to decide what to grow. They can thus all become suppliers of sugar cane and in addition to being paid for the cane, they will be able to buy ethanol at a lower cost. They can also exchange sugar cane in return for ethanol (sugarcane *bagasse*, which is the waste of the cane after is crushed, is used, among other things, as fuel for boilers), sell it, and even use it on their crops, avoiding spending money on fertilizers.

The group of producers will be paid for the work of production and sale of ethanol, and are also generating work for other families, with the cutting of sugar cane. They also save on energy, using sugar cane bagasse (waste obtained only from the craft production of rapaduras) to feed the boiler, to provide the heat needed for the process. To ensure that the purchase of ethanol is for stoves, all users need to be registered eliminating all possibility that the ethanol is diverted for other purposes.

The federal and municipal governments are responsible for the licensing and environmental guidance on the correct use of natural resources, and also for legislation on the production and sale of ethanol to facilitate access to markets. In addition to gaining from tax collection, they also benefit from savings on public spending on health problems related to domestic pollution. EMATER and INCRA,



which are government agencies for technical assistance and guidance on the correct use of cultivable land and agricultural production, can reduce the transfer of resources, since families are involved in a profitable activity, and can help other groups interested in MDE.

Project Gaia maintains its social objective of promoting access to clean-burning stoves, and

## Analysis of Livelihoods Outcomes

Regarding the use of the CleanCook stove, families consider several advantages compared to traditional wood-fired stoves and ovens using LPG gas. The issue of safety and speed were the most prominent, with the stove providing both a reduction of risk from leaks and a time saving on average 20 minutes per day in the kitchen. The stove was also considered economical, and easy to handle and clean.

It is important to note the issue of facilitating access to ethanol for families. The results obtained on the MDE were based on studies of production units from the State of Minas Gerais and on two studies on the implementation of MDE at the Settlement Dom Oriane in Betim.

Regarding the advantages and benefits of a micro distillery, the communities involved have seen positive

## Overall Conclusions

Besides promoting access to a clean burning stove and improving air quality in homes, Project Gaia has focused on spreading and replicating the micro distillery model to other countries, to facilitate access to ethanol. Biomass energy can be replicated in tropical countries due to climate conditions and the possibility of using other crops such as the mandioca, sweet-potato and Sorghum saccharino.

It is important to mention that this is not a monoculture of sugar cane associated with the production of food. This is a production chain of sugar cane, in this case, in addition to ethanol and the production of rapadura, which is a high energy food supplement. With the sub-products such as bagasse from sugar cane and vinhoto, as well as food for cattle, which will improve the production of milk and meat, high quality fertiliser can be produced, which results in increased production of food, and also sugar cane.

Considering the Brazilian reality, where thousands of farmers have left their lands as they do not represent

assisting in access to ethanol, therefore it has a responsibility to help families in the production of ethanol and access to markets. When the generation of income comes from ethanol, Project Gaia can allocate its resources to other projects, and it is also known for facilitating the search for new financial partners.

change, with the use of clean fuel in their homes, and the benefits arising from environmental and health issues as well as the diversification of production (sugarcane can be produced along with other crops). This would be mainly an activity for rural areas, to help promote the increase of family income through the cultivation of sugar cane and production and sale of ethanol, and generate a reverse rural exodus, by giving people the opportunity to generate income in their own lands and bringing farmers back to the countryside. It is important to mention that the production of ethanol through the sugar cane is one of the few activities in rural areas where the waste is used in the production and can also be processed into sub-products that will generate extra income for families.

a means of survival, living in precarious conditions in big cities resulting in an evident social exclusion, this project could promote a return to the countryside, creating favorable conditions to bring people back to the countryside, increasing their self-esteem and strengthening their livelihoods. More than just a simple project to generate energy, this is considered to be a “self-development” project as it promotes “self-sustainability” in energy and income increase through the sale of sub-products, facilitating the promotion to food access, either through the associated production of rapadura and dairy cattle, or the use of sub-products such as food for cattle and other organic fertilizer for crops.

It is worth highlighting that planting sugar cane for the production of ethanol in micro-distilleries, through co-operatives or associations, is an advantage for rural farmers, and will not generate conflict in the daily activities of communities.

<b>Initiative Name</b>	<b>Case 12 – Guatemala Jatropha Biodiesel</b> <i>Biofuels for Rural Development, Guatemala</i>
<b>Location</b>	<i>Chiquimula and Cuyotenango on the southern coast and western dry-zone of Guatemala</i>
<b>Initiation date and duration</b>	<i>Started January 2008, first stage of financing will end in 2009. The project has a minimum life of 5 years to take it to full performance.</i>
<b>Funder(s)</b>	<i>Started with USAID support</i>
<b>Project Initiator</b>	<i>TechnoServe</i>
<b>Overall Budget</b>	<i>\$250,000</i>
<b>Energy Output</b>	<i>An estimate of 1900 litres per ha is contemplated. One 200ha cluster will produce 380,000 litres of oil per year.</i>
<b>Area under cultivation</b>	<i>170 ha in Cuyotenango, with a plan to grow to 560 ha.</i>
<b>Beneficiaries</b>	<i>150 families in Cuyotenango, totalling 963 beneficiaries, and 8 villages in Chiquimula benefiting 193 families</i>

## Background and Context

Guatemala is highly dependent on fossil fuels. In 2007, 4,200 million litres of diesel were imported for national consumption. At the same time, the Ministry of Agriculture has identified more than 600,000 hectares of unproductive land – mostly deforested or depleted soil from repeated corn crops – that is suitable for the biofuel crop *Jatropha*, incorporating small owners and rural population. If all this idle land was used, it is estimated that the country has the capacity to substitute 80% of the imported diesel.

The Biodiesel for Rural Development project has as an objective the improvement of livelihoods for the poor in Guatemala adding an additional crop that produces income, and diversifying crops for soil recuperation. It was developed and is being implemented by TechnoServe, which is a nonprofit economic development organisation with global presence. Its mission is to help entrepreneurial men and women in poor rural areas of the developing world to build businesses that create income, opportunity and economic growth for their families, their communities and their countries.

The project's main idea is to add an additional product to the family economy that would not compete with food items, that would not displace forest land, and that could use marginal land to create an additional income. It will promote the formation of co-operatives of small producers to plant *Jatropha* and mainly sell the oil to larger processors and eventually to large companies.

The project area was selected because fences are planted with *piñón* (the local name for *Jatropha*) and the crop is already known and accepted. TechnoServe has worked intensely to transfer knowledge of usage and economic benefits, and coordinating farmers to work in outgrower clusters. To begin, the project involved an industrial partner who purchased the transesterification equipment. For future clusters, the co-operative itself will purchase the extraction equipment and sell the oil. TechnoServe supports preparation of business plans, designed to support small farmers in the vicinity. The ideal area of coverage is of 200 hectares per processing unit.

## The Initiative Market Map

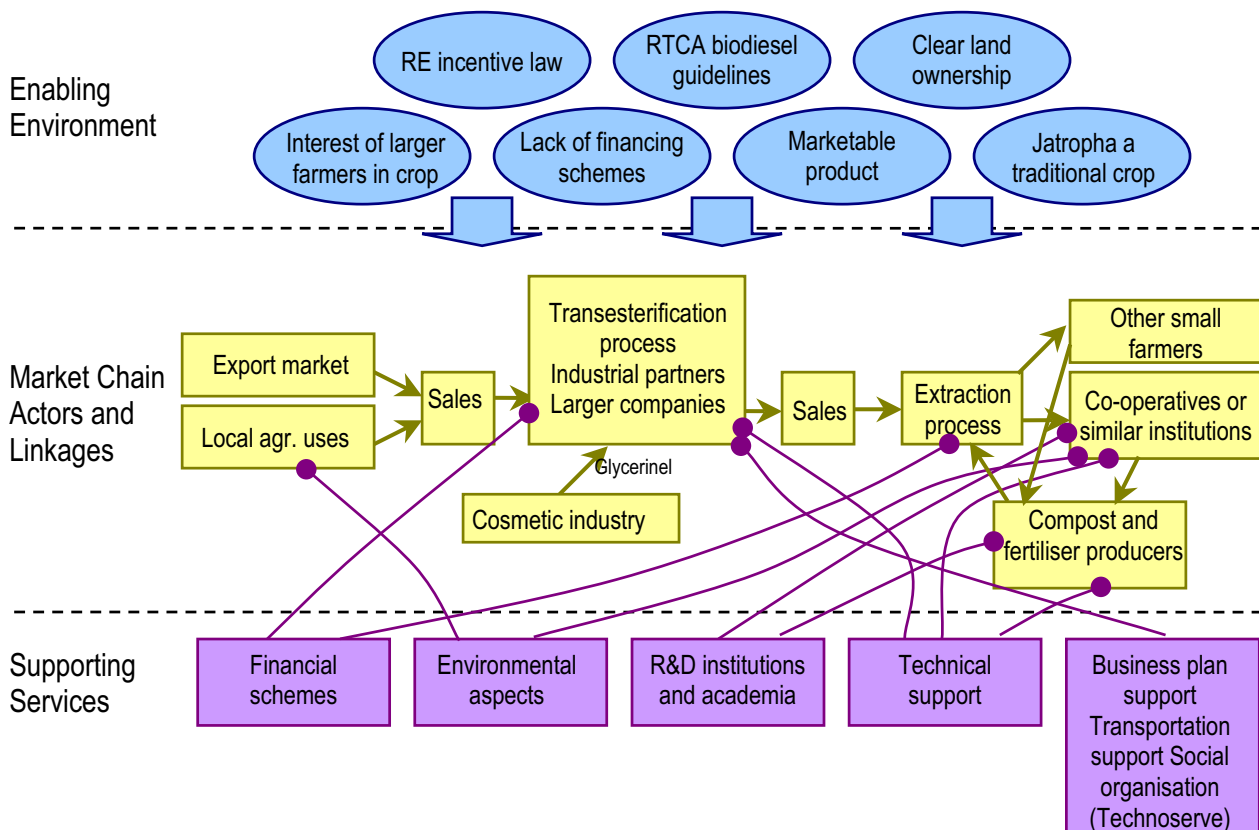

Within the main Market Chain, the base organisation proposed will be a co-operative or similar institution which will group small farmers into clusters. Once organised and trained, they can be empowered to access financing to purchase the extraction equipment to sell the oil. The next link is the involvement of an industrial partner who will purchase the transesterification equipment and buy the seeds from small farmers and process the product, because this step needs a high level of quality-control. For the first cluster, the main chain starts with the extraction of oil from *Jatropha* seeds by the donated equipment; then the small producers have the option to sell the oil or pay the industrial partner for the process and keep the biodiesel for personal use, or sale. The industrial partner will commercialise the product starting in the local agricultural market and after a certain volume is produced, considering exports to nearby countries or selling to a larger company. In new clusters, the total equipment could be acquired by the industrial partner, who will provide support and service to small farmers in the cluster.

The by-products include the seed shells, the seed-cake, and the leftovers of the fruit, which will be used to make fertiliser. The by-product of the transesterification

process (glycerin) will be sold to local cosmetics companies.

Within the Enabling Environment there are several positive factors. In the Tax & tariff Regime, the equipment falls into the renewable energy category and is eligible for tax incentives under the Law for Incentives for Electricity Production from Renewable Energy Resources. Another important supporting regime is the Guidelines in Central America for Biodiesel. The biodiesel project is also attractive for environmental purposes because its use reduces green house emissions from transportation. Because it is a local crop grown in many farms, farmers are interested in the product, mainly due to high costs of diesel, and a new product for the market.

Regarding Supporting Services, TechnoServe and other support institutions are focussed on training, teaching, guiding and supporting the effort of the initiative to reach the poor and improve livelihoods. Additionally the creation of strategic alliances with Universities and research centres with incorporation of larger local producers, as well as private investment, has been crucial.

TechnoServe is providing the transportation in the initial stages of the project's operation, although with small

farmers' families close to the plant, transport distances are short and as the project becomes established this service will end.

Because it is a new activity, the banking system is not yet attracted to financing biodiesel projects. However with projects like this one in operation, confidence

should grow within banks to provide financial services for such projects. This can be seen as a current negative factor, but with proven experiences, it can change.

## Relationships between Market Actors

	Co-operative or similar organisations	Fertiliser preparation groups	Industrial partners	Extraction plant (owned by the co-op)	Transesterification plant (owned by the industrial partner)	TechnoServe
Co-operative or similar organisations						
Fertiliser preparation groups	<b>Good.</b> Provision of organic fertilizers at lower prices is attractive					
Industrial partners	<b>Good</b> – formal, commercial	<b>Good,</b> possible buyers				
Extraction plant (owned by the co-op)	<b>Good,</b> service and income to co-op	<b>Good,</b> possible buyers	<b>Good,</b> possible buyers			
Transesterification plant	<b>Good,</b> financial service contractual	n/a	Financial, service, contractual. The industrial partner is responsible for the quality of the product.	Production agreement, contractual. The quality of the final product is responsibility of the industrial partner.		
TechnoServe	<b>Good</b> - basic organisation, initial support, training	<b>Good</b> - technical support, training	<b>Good</b> - technical support in business plans	Training, initial donation in some cases, support in financial process. Oil extraction is simple, and with adequate training, it can be carried out with acceptable quality for the next step.	Technical advisory in business plan. The industrial partner is responsible for quality and an important part of the training in the business plan.	

To start the first cluster, the project was able to find a donation to buy the extraction equipment. The industrial partner purchased the transesterification equipment for biodiesel production, and provided a space in his warehouse to place the extraction equipment owned by the first cluster. In future projects, the industrial partner could purchase both equipments

and provide the service and support to small farmers in his cluster.

The project plans to form groups of small farmers organised into co-operatives (or similar organisations) to manage the *Jatropha* plantations and fences, complemented with an industrial partner who will

process the product. Once the crop is ready, recollection of seeds from production locations will be coordinated by a transportation arrangement, for which a small fee is being considered. Once the seeds arrive to the processing unit, oil is extracted, and processed into biodiesel. The seed cake is used to produce fertiliser, to be sold later to interested users.

The importance of the industrial partner is the quality control of production. Later on, when a critical mass of

biodiesel is produced, quality will be an important factor for exports, commercialisation at wider levels etc.

The organisations that will be formed pulling together small farmers will grow the plants, collect the fruit, and extract the seeds. They will use shells, fruit and seed-cake to produce fertiliser. The seeds will be transported to the processing plant and payment will be made according to the contract with the industrial partner. The relationship is interdependent and currently has no competition or competing interests.

## Balance of Rights, Responsibilities and Revenues

	Rights	Responsibilities	Revenues
<b>Co-operative or similar organisations</b>	<ul style="list-style-type: none"> <li>- Use of their land</li> <li>- Right to plant selected crops</li> <li>- Marketing decision on whether to sell oil to industrial partner or other market actor</li> </ul>	<ul style="list-style-type: none"> <li>- Delivery of seeds</li> <li>- Payment of processing fees</li> </ul>	<ul style="list-style-type: none"> <li>- Sale of seeds or biodiesel</li> <li>- Improvement in corn yields</li> <li>- Less expensive fertilisers</li> </ul>
<b>Fertiliser preparation groups</b>	<ul style="list-style-type: none"> <li>- Use of by products</li> <li>- Earn revenue for their work</li> </ul>	<ul style="list-style-type: none"> <li>- Follow quality control and process for fertiliser</li> </ul>	<ul style="list-style-type: none"> <li>- Sale of fertiliser</li> </ul>
<b>Industrial partners (Large producer)</b>	<ul style="list-style-type: none"> <li>- Use of their land</li> <li>- Right to plant selected crops</li> <li>- Decision on selling the biodiesel, or self-commercialisation</li> </ul>	<ul style="list-style-type: none"> <li>- Delivery of seeds</li> <li>- Payment for processing fees</li> <li>- Co-ordination of transportation</li> </ul>	<ul style="list-style-type: none"> <li>- Sale of biodiesel</li> <li>- Less expensive fertilisers</li> </ul>
<b>Extraction plant (owned by the co-op)</b>	<ul style="list-style-type: none"> <li>- Charge a fee for the service</li> <li>- Charge a low fee for by-products sold to the women of small producers</li> </ul>	<ul style="list-style-type: none"> <li>- Good maintenance of extraction equipment</li> <li>- Careful weights and inputs from producers</li> </ul>	<ul style="list-style-type: none"> <li>- Fee for processing</li> </ul>
<b>Transesterification plant (industrial partner of large company)</b>	<ul style="list-style-type: none"> <li>- Charge a fee for the service</li> <li>- Process oil for commercialisation</li> </ul>	<ul style="list-style-type: none"> <li>- Good maintenance of equipment</li> <li>- Comply with the purchase agreement</li> <li>- Comply with quality control requirements</li> </ul>	<ul style="list-style-type: none"> <li>- Processing fee</li> <li>- Sale of biodiesel</li> </ul>
<b>TechnoServe</b>	<ul style="list-style-type: none"> <li>- Publications of research material and results from the project</li> <li>- Replicability</li> </ul>	<ul style="list-style-type: none"> <li>- Support to small producers in technical matters</li> <li>- Co-ordination with larger producers</li> </ul>	<ul style="list-style-type: none"> <li>- Income from donors</li> <li>- Non-profit</li> <li>- Co-ordination with local agencies</li> </ul>
<b>Academia, investigation organisations</b>	<ul style="list-style-type: none"> <li>- Publications of research material and results from project</li> <li>- Replicability</li> </ul>	<ul style="list-style-type: none"> <li>- Support to small producers in technical matters</li> <li>- Publication of results</li> </ul>	<ul style="list-style-type: none"> <li>- Possibility of donations, grants, etc.</li> </ul>

Regarding Rights, the target group is small farmers that received land from the Government. Local industrial partners are interested in biodiesel due to the high cost of fuel, and are coming into the business with

investment for planting *Jatropha* in larger areas, acquiring equipment and bringing the project to a working capacity that will produce revenues for both the poor and well established.

A three pillar strategy was planned with a value chain and selected partners. The first pillar is the small producers organised in co-operatives or similar organisations, and TechnoServe partnered with USAID and AEA (Energy and Environment Agency). The second pillar is research and development and here the partners are Guatemalan universities and private research companies. The third pillar is formed by large scale investors, which will come into play once several clusters are in operation, buying the oil directly from the co-operatives, or through the industrial partners.

In terms of Responsibilities, the small farmers' association and in some cases the industrial partner, plant and collect the *Jatropha* seeds. The co-operative is responsible for the extraction process and sale of oil. The owner of the transesterification equipment is

responsible for quality and commercialisation. The by-products are processed in the communities, using the shells, the left over fruit and the seed-cake to prepare organic fertilizer for local use/sale. TechnoServe has the responsibility to support technical aspects, organisation of the small farmer's communities and the incorporation of industrial partners through business plans.

Regarding Revenues, in the general plan, the industrial partner purchases the oil. In the pilot program the small farmer has the option of selling the oil, or paying a fee and taking the biodiesel from produced, under a one year pre negotiated contract. Once several clusters are in place, the entrance of larger companies is considered, either to process or simply to purchase the oil.

## Analysis of Livelihoods Outcomes

In terms of Financial Capital, the Guatemala biofuels program can have a significant impact on poverty reduction, by providing extra income to small farmers. The introduction of a crop that grows in marginal areas, and can be planted with corn, is particularly attractive. In the corn production economic analysis, these small producers typically generate a total income of \$1,500 per year, or approximately \$0.70 per person per day. With the *Jatropha* opportunity, the income from 1 ha will total \$1265, (oil \$930 + fertilizer \$620, minus \$285 costs). If we add this to the \$1500, the new total is of \$2765/year, or approximately \$1.25 per person per day.

Natural Capital is enhanced by the project through improvement of the soil with organic fertilisers from the seed cake residues of the *Jatropha* processing.

In the TechnoServe model, producers are organised to generate scale for the industrial process with the

participation of larger actors who will invest in the production equipment, the main Physical Capital needed for the initiative.

Human Capital has been enhanced through training of small farmers and entrepreneurs while in general the relative strengths of different types of actors (researchers, entrepreneurs, farmers etc) have been harnessed in this project to enable the creation of a value chain which previously did not exist.

Social Capital has been developed through the establishment of co-operatives and clusters of producers. Additionally the support to the farmers' organisation assists collective action by the small farmers, improving their influence within the system, and enabling them to develop other support actions, such as co-operative shops, purchasing in bulk for members etc.

## Overall Conclusions

*Jatropha* is considered a particularly good option in marginal area of Guatemala as it requires low watering, has high adaptability to soils with low nutrient content, and enriches the soil with nitrogen and potassium. It yields approximately 1900 litres per hectare per year, has low implementation costs and a long life span (30 – 50 years). It is also common in Guatemala, where it is used in fences. It can have a high economic value in biodiesel and sub-products such as organic fertilizer, briquettes and biogas from seed-cake, shells and fruit. It can also provide opportunities for women in the communities responsible for by-product production.

Many small farmers in the settlements have ideal land, which is poor and has no crops planted, making this project a possible win-win, for the small farmer, the environment and the country as a whole.

Key challenges to the project moving forward will be ensuring the continued participation and flow of benefits to small farmers as volumes increase. Additionally, the energy access benefits to rural people will also be an important test of its long term impact on rural livelihoods.

<b>Initiative Name</b>	<b>Case 13 - Peru Veg-Oil Recycling</b> <i>Vegetable oil recycling and use in Peri-Urban areas around Lima</i>
<b>Location</b>	<i>Lima, Peru</i>
<b>Starting Date and Duration</b>	<i>Starting year 1998, duration 10 years and starting year 2004, duration 4 years.</i>
<b>Funders</b>	<i>Self-financing</i>
<b>Project Initiator</b>	<i>Small business entrepreneurs Rafael Tam Siu and Agustín Jacobo González</i>
<b>Overall Budget</b>	<i>Not determined</i>
<b>Output</b>	<i>500,280 litres. biodiesel per year, approximately 41,690 litres per month and 295,620 litres of biodiesel per year, approx. 25,500 litres per month.</i>
<b>Area of Land</b>	<i>Not applicable</i>
<b>Beneficiaries</b>	<i>Service stations, transporters, bakeries, occasional private customers.</i>

## Background and Context

Biodiesel in Peru is a new industry which needs to be developed, from the production of raw materials to the logistics of distribution and from knowledge about the product to market demand. There are some well established companies with installed capacity, but which have not yet entered into the productive phase. Production is concentrated in small rudimentary businesses, located in the peri-urban area of the city of Lima.

Taking into account difficulties in obtaining raw materials and the high international prices of agricultural inputs and food, the task of making biodiesel production a profitable industry looks particularly challenging. The price of used oil has increased in the informal market by almost 100% over previous years.

Biocombustibles del Peru is a small company set up by Rafael Tam in 1998. Mr Tam had previously worked for a company related to the sale of petroleum products, where he learned about Natural Gas and the production of biodiesel. There he saw the opportunity to establish a business in biofuels as a viable alternative as it is easy to produce and it does not require making changes in the engine. Initially, Mr Tam studied the entire process, beginning with the collection of oils. He began working with fast food chains and supermarkets, collecting the

oil and monitoring it, in order to maintain certain quality standards.

Another illustrative case is that of Mr Jacobo, who became interested in biodiesel production as an alternative source of income when he shut down his building materials business. Mr Jacobo sought information on the internet about how to produce biodiesel, and once he had developed his product, he attended a training course conducted jointly by the NGO Soluciones Prácticas-ITDG (Practical Action) and Universidad Nacional Agraria La Molina.

In both cases these are informal businesses. The formalisation process to become an authorised biodiesel producer is very complex and expensive which, in most cases, renders small producers unable to do so. Biocombustibles del Peru is registered as a producer at the Ministry of Production, and has a permit to produce biodiesel and collect waste oils. However, to comply with all legal requirements, it needs permission from the Ministry of Energy and Mines and OSINERGMIN, The Energy and Mining Investment supervisory body. Mr Jacobo has been unable to formalize his business at any stage. Despite this, both companies collect oil and have established good relationships and contacts with other market chain actors.

## The Initiative Market Map

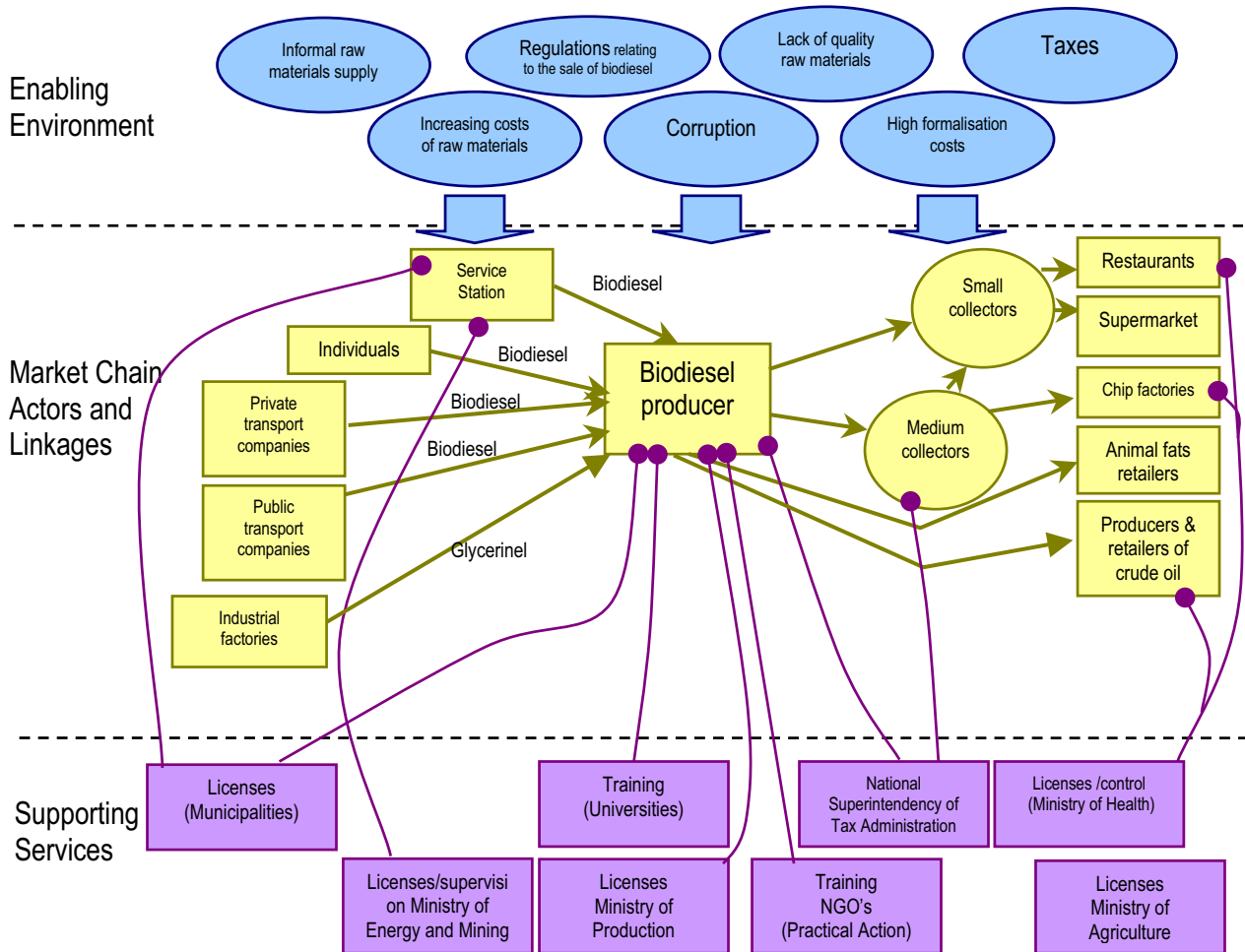

The main feature of the chain is the atomisation of vendors and informality in trade relations. The suppliers of oil are shops that sell food (restaurants, fast food outlets and neighborhood diners), which sell directly to the biodiesel producer. There is also a network of small collectors, who gather the product as edible oil and, at a lower scale, animal fat, in an informal manner so as to evade health authorities. There are formal systems of solid waste collection provided by companies (such as EPS-RS) which are formally constituted and are the only ones that can lawfully perform these functions. Finally, there are sellers of ‘virgin’ animal oils, which come from birds, fish and other animals, who will transport the oil directly to the biodiesel manufacturer.

Biodiesel, once produced by these small businesses, is marketed to different consumers: fuel suppliers, public transport companies, individual consumers, companies using the product for their fleets of vehicles and factories using it for their boilers. Biodiesel producers also, in some cases, receive the used oil from the suppliers (for example a fast food chain) transform it

into biofuel and gives it back to the same suppliers who pay for the service. A characteristic of the existing business relationships in the chain is the informality: both the supply of raw materials, primarily used edible oil as well as the biodiesel produced are sometimes delivered without invoices and without following certain basic sanitary measures.

There is also a relationship with the suppliers of chemical products for the production of biodiesel. There is a formal commercialisation of these products between the distributors of chemical components and the producers of biodiesel.

NGOs and universities, such as Practical Action (Soluciones Prácticas-ITDG) and the Universidad Nacional Agraria La Molina, train the small producers so that they can get a quality product and maintain consumers’ confidence towards the use of biodiesel. On the other hand, there is ignorance on the part of the authorities over biodiesel production and the informality of trade relations present in the chain, due primarily to the complex legalisation procedures mentioned above.



The two cases mentioned above are not considered competitors in the market. In the case of Rafael Tam, he would like to produce at larger scales. His business relations are very good; he invests in the business and

would like to have a formal production chain. For this reason his market is different from Agustín Jacobo's market. Agustín sells to the local market informally and has a traditional (artisanal) production.

## Relationships between Market Actors

	Chemical component providers	Small collectors of vegetable oils	Medium collectors of vegetable oils	Biodiesel producers	Gas stations	End consumers
Chemical component providers						
Small collectors of vegetable oils	None					
Medium collectors of vegetable oils	None	Fair, Informal, competitive				
Biodiesel producers	Good, formal, commercial	Good, informal, commercial	Good, informal, commercial			
Gas stations	None	None	None	Good, commercial		
End consumers	Informal, commercial	None	None	Fair, informal, commercial	Good, formal, commercial	

As far as oil providers are concerned, a distinction should be made between the providers of used edible oil and those of animal fat. The former sell the oil directly to the producer in small quantities, or through collectors. The latter sells the oil directly to the biodiesel producer, without any intermediary. Introducing this product to the market is complicated because of its uncertain quality originated from the extraction methods that are used.

The small oil collector tours the various establishments in the city of Lima, at night or at dawn, to get the product used during the day or week, depending on the size of the business, and sells it directly to the biodiesel producer or to a bigger collector who works informally and surreptitiously, operating in marginal and dangerous areas of the city. They store it in 100-litre drums or in water tanks. The medium collector also gathers used car oil, which is used for other activities.

The biodiesel producer buys vegetable oils from these suppliers, produces biodiesel and sells the product on

an informal basis to some public transport companies and small factories near the production site. As can be noticed, trade relationships among the different actors in the chain are mostly informal, and in a clandestine atmosphere, hiding from authorities, who in some cases, when they witness commercial operations, demand bribes not to intervene.

All relationships are purely commercial. There are no donors or any kind of financial support available. Producers invest their money or get bank loans, or in some cases, get informal loans to carry on with their businesses.

For example, Mr Jacobo only succeeds in making a profit when he can get oil for less than \$10 per 18 litre can. The biodiesel market has not yet developed, although there are expectations about potential demand as of 2009, indicated the entrepreneurs of this small business.

## Balance of Rights, Responsibilities and Revenues of Market Actors

	Rights	Responsibilities	Revenues
<b>Oil Providers</b>	- To sell used oil	- Ensure oil does not get contaminated	- Income for the sale of used oil - Income for the sale of vegetable oil - Income for the sale of animal fat oil
<b>Small collectors</b>	- None, they act informally and semi-underground	- Not to alter the composition of the raw material	- Proceeds from the purchase and sale of used oil
<b>Medium collectors</b>	- None, they act informally and semi-underground	- Not to alter the composition of the raw material	- Proceeds from the purchase and sale of used oil
<b>Biodiesel producer</b>	- To produce biodiesel - To collect waste oils - No clear permission for operation from Ministry of Energy	- To inform the suppliers how to store the oil in order to avoid contamination - To observe the necessary safety measures - To make biofuel (he has the capacity and the knowledge) - To have a good quality product - To look after the health of workers	- Income from sale of biodiesel to gas stations, transport companies, etc - Income from sale of glycerine to end consumers (brick companies, factories, boilers, etc.)
<b>Gas stations</b>	- To have biodiesel available for sale	- They must not buy altered fuel	- Income for the sale of biodiesel to consumers
<b>End consumers</b>	- To have an economical product for their activities	- They must not buy altered fuel	- Purchase of biodiesel which permits lower operational costs

With regards to **rights**, the oil providers have the right to market the used oil for a marginal gain. There are no clear rules governing this market, so all those involved in marketing (especially small and medium collectors who trade informally), are exposed to the arbitrariness of the authorities. Biodiesel manufacturers say that regulatory authorities should be familiar with regulations and production standards, so as not to accuse biofuel producers of illegal activities due to their ignorance. The producers suggest that municipalities carry out a campaign in restaurants supporting of the use of used edible oil in biodiesel, regulating its disposal and recycling to ensure a greater amount of raw material available. Gas stations have the right to sell biodiesel and other users are entitled to acquire a product that allows them to reduce their operating costs. In the case of biodiesel users, they do not know that the product they are using has been obtained informally (in most of the cases) by oil providers. If gas stations want to sell biodiesel, they have to buy the mixture (diesel oil and biodiesel) from a wholesaler, who would have to buy it from a licensed registered producer (this system does not allow small providers to sell to mixing centres). This makes small scale trade of biodiesel an informal business and also affects quality.

In terms of **responsibilities**, the oil providers have the duty to ensure that used edible oils are not contaminated with water or detergent. Small and medium collectors have the duty not to alter the oil they trade. The biodiesel producers feel they have the duty to inform their raw material suppliers about the procedures to follow to avoid polluting it. The producer also feels it is his duty to take necessary safety measures as well as to supervise the manufacturing process. The gas station owners have the moral obligation to buy biodiesel rather than adulterated fuel or to tamper with the fuel.

The oil providers generate **revenues** from the sale of their oil. Small and medium suppliers earn money from the used oil they trade. For medium collectors the sale of used edible oil is just a part of their income, since they also sell used oil from automobiles. For the biodiesel producer, the current gains are not significant. They report that the business is not profitable due to the increase in the price of raw materials, mainly oil, and because they have to compete with informal soap manufacturers and even illegal oil recyclers. The income that allows them to give sustainability to companies comes from producing and selling other products, such as glycerin (by-product from biodiesel

production) which is sold to end consumers for brick companies, etc. The gas stations obtain profits from the sale of biodiesel to the public transport units and end consumers, who attain a benefit by reducing their

operating costs by selling a product (a mix of biodiesel and diesel oil) at the same price as the diesel oil, making a few cents per gallon of biodiesel.

## Impacts on Livelihood Assets

In terms of **financial capital** the biodiesel business is vulnerable, risking the sustainability of enterprises, with little or no return offered to producers due to increased prices and scarcity of raw materials, both natural oils/fats and used edible oil. There are other contextual factors such as lack of financial support from the government or the formal banking system, forcing producers to turn to informal financing systems, which can charge monthly fees of 20%. Another factor is the absence of an efficient chain, with a starting point in the cultivation of raw material (palm, canola, pine nuts, etc), which has its own problems (such as lack of seeds, land, agricultural financing, and water, among others). Mr. Tam (Biocombustibles of Peru) tried to promote their cultivation, but failed due to the aforementioned disadvantages. He is now investigating the production of oil from micro algae.

The existing biodiesel plants were implemented with equity capital. In terms of infrastructure, the requirements for production are not very demanding, the plants are small and artisanal.

The aspects that currently sustain the existing biodiesel manufacturing business are **human and social capital**.

The owners are highly trained, both technologically and in business. They are also entrepreneurs with a vision of complementary businesses to sustain business initiatives. With regard to social capital, it appears that manufacturers have succeeded in establishing a network of actors around their businesses. On the one hand, family members or friends involved in the business of selling cooked food provide the raw material, the used edible oil; on the other hand, the manufacturer offers jobs in the area where the plant is located, taking a kind of "social license" delivered by the local population, as it constitutes a source of employment for the youth of the area.

Mr. Jacobo only buys oil when the price is less than US\$11; if the price is higher he does not but it as he would not make a profit when selling the biodiesel, and if he did it would be too low. In the case of Rafael Tam, he collects the oil himself, so he can control the quality and lower the price of transport.

The impact on **natural capital** would occur when all actors in the production chain recycle the oil avoiding oil being disposed off through drains, causing damage to the environment, especially water pollution.

## Overall Conclusions

Today the biodiesel business is not a profitable activity in Peru. It is in a situation of vulnerability due to structural conditions (lack of natural inputs) and contextual ones (increase in the price of raw materials such as used edible oil). Producers have to compete for the raw materials with the informal and even illegal activities (such as the recycling of edible oil). There is also much ignorance of the business on the part of the authorities, lack of clear rules for supplying raw material, mistrust amongst the various players in the current market chain, and little apparent interest on the part of the government in promoting an efficient and competitive biodiesel production chain.

While all the other players in the chain win (the owners of the eating establishments for the sale of prepared food, the small and medium collectors, the owners of the gas stations, etc.), the biodiesel producer has low or no profits, holding his business afloat by selling other products, such as glycerin. With regard to the market,

demand is small, because consumers are not familiar with the product. In order to sell on the formal market, it is necessary to have licenses and in this case it could only be sold to authorised companies. This means that it could not be sold directly to gas stations as is current practice. There is also much ignorance about the attributes of biodiesel. These two factors contribute to the vulnerability of the biodiesel manufacturing business. In Peru, there are three plants with a large capacity to produce biodiesel. They have been inaugurated recently but have not yet started producing due to the high cost of raw materials, making the end product more expensive than mineral diesel. The biodiesel market is currently a small business, with many problems. Had it not been for the personal abilities, both professional and businesslike, of the biodiesel manufacturers and the support network they have, the businesses would not have been able to establish and move forward.

<b>Initiative Name</b>	<b>Case 14 - Thailand Jatropha Co-operative</b> <i>Zero-waste management in Jatropha production for biofuel development in small scale farmer communities</i>
<b>Location</b>	<i>Viengsa District, Nan province, Northern Thailand</i>
<b>Initiation Date and Duration</b>	<i>1<sup>st</sup> October, 2006, 5 year duration</i>
<b>Funders</b>	<i>Matching funded by the Department of Co-operative Promotion (\$30K), the Co-operative League of Thailand (\$10K), Nan Provincial Governor (\$30K) and Viengsa Agricultural Co-operative (\$30K).</i>
<b>Project Initiator</b>	<i>Kasetsart University in co-operation with the Co-operative League of Thailand</i>
<b>Overall Budget</b>	<i>\$100,000</i>
<b>Output</b>	<i>292,000 Kg Jatropha seeds p.a., 365,000-730,000 Kg fertilizer p.a., 73,000 Litres of biofuel p.a., 500 KW small scale power plant, 1,825,000-2,190,000 kg charcoal or biomass p.a.</i>
<b>Area of Land</b>	<i>To date about 240 hectares (120 hectares per community). Expected to reach about 600 hectares (5 communities)</i>
<b>Beneficiaries</b>	<i>To date 1,000 farmers- Income, Expected to reach 2,500 farmers- Income, 500 Households- Electricity, 5,000 Farmers- Fertilizer</i>

## Background and Context

A middle-income country in Southeast Asia, Thailand has made important progress in social and economic development since the Asian financial crisis of the late 1990s. Today, the Thai economy is driven by exports of electrical goods and agriculture. More than 40% of the population works on farms and rice is the most important crop in the country. In Thailand, access to electricity by the poor reached more than 99% by 2001. 62% of domestic energy demand is met by imports of fossil fuels and biomass energy accounts for more than 44% of supply from domestic sources.

In Viengsa District, primary sources of income are corn, soyabean, vegetables, longan (fruit), pigs, fish and cows and the average daily wage is \$6. Aside from low wages, lack of land ownership is also a vulnerability issue for the local population as access to land for crop production is vital for securing a livelihood. The most important natural resources available to the local population are fresh water and forests, although the latter is being cut down year on year. Between 1990 and 2005, total forest cover reduced by 9.05%, or 1,445,000 hectares (Mongabay, 2008). Energy supply for households is predominantly gas and charcoal for cooking and petroleum for machinery and transport. Increases in the international price of petroleum have caused agricultural production costs to rise. One method for reducing fuel costs is for farmers to use renewable energy, such as biodiesel from Jatropha, to power farm machinery. Jatropha has many advantages for small scale farmers- it is a versatile crop, drought tolerant,

fast growing and suitable for cultivation in various soil conditions.

In 2006, the University of Kasetsart began working with 500 farmer members of the Viengsa Agricultural Co-operative to develop Jatropha production, primarily for biodiesel. The rationale behind the project was that Jatropha could form the basis of a community-level income and employment generation programme. The plant grows very quickly, is drought resistant and produces seeds all year round when irrigated. Jatropha seeds are processed to produce biodiesel which provides fuel for electricity generation, farm machinery and local transport. Besides its known value as an energy crop, other parts of the Jatropha plant have economic value and are sold by the farmers to generate important additional income. The cakes and hulls yield good quality organic fertilizer while the leaves and stems are used for fuel, either as biomass or charcoal. Paper and particle boards will be made from the stems and branches as well as handicrafts once initial market research has been undertaken and potential for sales identified.

\$100,000 funding was secured to provide training for farmers in land and seedling preparation, transplanting and spacing, water and pest management, fertilizer application, harvesting, drying and storing and equipment for Jatropha production. The project is currently in its second year of implementation. Out of a total 5,000 co-operative members, 500 farmers attended an initial training course

on Jatropha production. More than 1,000 farmers have now been trained and are growing Jatropha for sale. It is intended that over the next three years, a further three

communities will receive training totalling 2,500 farmers in the District.

### The Initiative Market Map

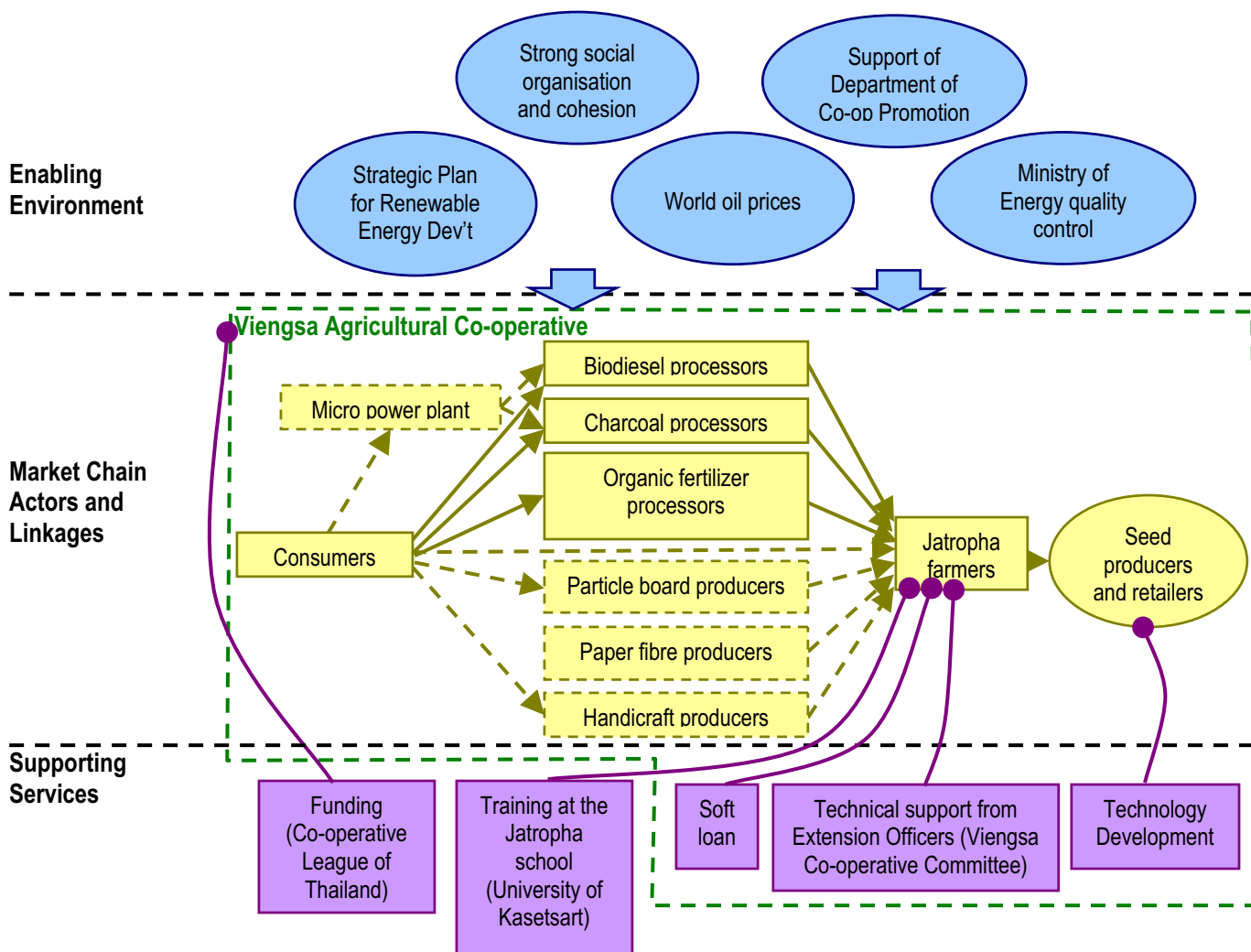

With respect to the enabling environment, the Thai Government's Strategic Plan for Renewable Energy Development strongly advocates the production of renewable energy for national use and contains a key target to increase the renewable energy share of commercial primary energy to 8% by 2011. In 2006, the Government produced a roadmap for biodiesel and bioethanol production. The biodiesel roadmap sets out a vision for 2012 when it is anticipated that production capacity will be sufficient to serve the entire nation. The initial focus of the roadmap is, however, on community-based biodiesel production for local use. The Ministry of Energy quality control guidelines will apply once biodiesel is sold outside the Co-operative.

The Jatropha supply chain has been developed by two main institutions: The University of Kasetsart and the Viengsa Agricultural Co-operative. The University of Kasetsart initiated the project, identified the key partner

- the Viengsa Agricultural Co-operative - and secured the necessary funding. Viengsa Agricultural Co-op was established in 1970 to help farmers reduce the cost of production and today has around 6,000 members. Jatropha requires a reasonable scale of production in order for a small scale industry to be set up at community level. A sufficient number of farmers in the Viengsa Co-operative were interested in Jatropha development hence the co-operative was selected to take part in the project. A particular advantage of the Viengsa Co-op is that its members receive a soft loan to buy the raw materials required for crop production from the seed retailers (also Co-op members), thus making it easier for farmers to be involved.

The Co-op and its members are the principle Market Chain Actors in this project and their working relationships are key to its success. Once harvested by the farmers, the seeds, hulls, leaves and stems are sold

on to other members of the Co-op for processing. Biodiesel is sold to members of the Co-op about 20% cheaper than open market cost, with priority going to those members who need fuel for tractor engines. Organic fertilizer is recommended by the Co-operative for use by community members on crops such as rice, vegetable and fruit. Charcoal is sold direct to households for use in cooking. A community micro power plant is also due to be set up. Biomass or charcoal will be sourced from Co-operative producers to power the plant's steam turbine. This power plant will serve five to ten nearby communities within a 50Km radius (all Co-operative members). It is also anticipated that once some market research has been conducted

by members, paper fibre, particle board and handicrafts will also be produced for sale.

In terms of Supporting Services, the University established and runs the Jatropha School which provides training on Jatropha production and processing into marketable products. By September 2008, more than 5,000 participants had graduated from the school. The project has also trained participants to design and construct machinery to process the various parts of Jatropha into products to suit different scales of production. The Co-op provides supporting services to its members in term of the aforementioned soft loan, technical support in seed production from extension officers and technology support to the biodiesel processors.

## Relationships between Market Actors

	Farmers	Seed retailers	Biodiesel processors	Charcoal processors	Fertilizer processors	Viengsa Co-operative Committee	Kasetsart University	Dept of Co-operative Promotion	Co-operative League of Thailand
Farmers									
Seed Retailers	Good formal, financial								
Biodiesel processors	Good, formal, financial	None							
Charcoal processors	Good, formal, financial	None	None						
Fertilizer processors	Good, formal, financial	None	None	None					
Viengsa Co-operative Committee	Good, formal, financial & technical	Good, formal, financial & technical	Good, formal, financial & technical	Good, formal, financial & technical	Good, formal, financial & technical				
Kasetsart University	Good, technical	None	None	None	None	Good, formal, technical			
Department of Co-operative Promotion	None	None	None	None	None	Good, formal, financial	Good, formal, financial		
Co-operative League of Thailand	None	None	None	None	None	Good, formal, financial & technical	Good, informal, technical	Good, formal, regulatory & financial	

Dr Sombat Chinawong is the staff member at the University of Kasetsart responsible for project implementation and monitoring and is the resident Jatropha development expert. The University approached donors to secure funding but the University itself pays for staff working at the Jatropha School. The Co-operative League of Thailand has signed a Memorandum Of Understanding with Viengsa

Agricultural Co-op to provide financial resources for this project and is also responsible for inspecting all the Co-op's activities. The relationship between the University and the Co-operative is purely technical, with the University providing research, training and technical support at the school. Co-op members who want to take part in the Jatropha development project nominate themselves for inclusion. Members then sign an

agreement with the Viengsa Agricultural Co-operative Committee which is renewed on a yearly basis. Relationships between the different co-operative members are formalised via contracts established and overseen by the Co-operative Committee. These agreements fix and guarantee prices for raw materials and Jatropha products. Farmers receive financial support from the Co-operative in the form of a soft loan, which is formalised with a contract. Farmers also receive some technical support from Co-operative Extension Officers. The Department of Co-operative Promotion is part of the Ministry of Agriculture and Co-

operatives and is the lead Government agency to promote and develop co-operatives and farmer groups. The Co-operative League of Thailand (CLT) is a nationwide confederation of the co-operative movement operating under the Government's Co-operative Act. The CLT receives funding from and is also regulated by the Department of Co-operative Promotion. The Viengsa Agricultural Co-op also receives funding from the Department of Co-operative Promotion to support the purchase of equipment. The CLT has provided funding for this project, as well as providing technical support more generally.

## Balance of Rights, Responsibilities and Revenues of Market Actors

Actors' 3Rs'	Rights	Responsibilities	Revenues
Farmers	<ul style="list-style-type: none"> <li>- Use of land for farming</li> <li>- Sales of Jatropha products</li> <li>- Buy biodiesel as a priority user</li> <li>- Land rights</li> </ul>	<ul style="list-style-type: none"> <li>- "Caretakers" of the land and natural resources; Cultivating the crops</li> <li>- Jatropha harvest and delivery to the various processors</li> <li>- Repay soft loan with interest</li> </ul>	<ul style="list-style-type: none"> <li>- Income from selling Jatropha products</li> <li>- Loan from Co-operative</li> </ul>
Seed retailers	<ul style="list-style-type: none"> <li>- Selling Jatropha seeds</li> </ul>	<ul style="list-style-type: none"> <li>- Produce seeds and sell to farmers</li> </ul>	<ul style="list-style-type: none"> <li>- Income from selling seeds</li> </ul>
Biodiesel processors	<ul style="list-style-type: none"> <li>- Selling biodiesel</li> </ul>	<ul style="list-style-type: none"> <li>- Press seeds and produce biodiesel</li> <li>- Sell to the Co-operative members</li> </ul>	<ul style="list-style-type: none"> <li>- Income from selling biodiesel</li> </ul>
Charcoal processors	<ul style="list-style-type: none"> <li>- Selling charcoal</li> </ul>	<ul style="list-style-type: none"> <li>- Produce charcoal and sell to member households</li> </ul>	<ul style="list-style-type: none"> <li>- Income from selling charcoal</li> </ul>
Fertilizer processors	<ul style="list-style-type: none"> <li>- Selling fertilizer</li> </ul>	<ul style="list-style-type: none"> <li>- Produce fertilizer and sell to Co-operative members</li> </ul>	<ul style="list-style-type: none"> <li>- Income from selling fertilizer</li> </ul>
Viengsa Agricultural Co-operative Committee	<ul style="list-style-type: none"> <li>- Voluntary and open membership</li> <li>- Democratic member control</li> <li>- Autonomy and independence.</li> </ul>	<ul style="list-style-type: none"> <li>- Provide loans to members</li> <li>- Committee and Members' meetings</li> <li>- Marketing Jatropha products to members</li> <li>- Fixing prices for products</li> <li>- Contracting between members</li> </ul>	<ul style="list-style-type: none"> <li>- Re-paid loans with interest</li> <li>- Grant from project donors</li> </ul>
Kasetsart University	<ul style="list-style-type: none"> <li>- Undertake academic activities</li> </ul>	<ul style="list-style-type: none"> <li>- Project development and coordination</li> <li>- Human resource development</li> <li>- Farmer training</li> <li>- Advice and consultation</li> <li>- Technical assistance</li> <li>- Farm research</li> </ul>	<ul style="list-style-type: none"> <li>- Funding from project donors for technical support</li> </ul>
Department of Co-operative Promotion	<ul style="list-style-type: none"> <li>- Promote Co-operatives throughout the country</li> </ul>	<ul style="list-style-type: none"> <li>- Provide financial support to the Viengsa Agricultural Co-operative for investment in equipment</li> </ul>	<ul style="list-style-type: none"> <li>- Funding from Central Government</li> </ul>
Co-operative League of Thailand (CLT)	<ul style="list-style-type: none"> <li>- Promote, develop and set standards for Co-operatives in Thailand</li> </ul>	<ul style="list-style-type: none"> <li>- Provide financial support to the Viengsa Agricultural Co-operative</li> <li>- Provide technical assistance</li> <li>- Control and inspect Co-operative activities</li> </ul>	<ul style="list-style-type: none"> <li>- Subscriptions</li> <li>- Government subsidies</li> <li>- Donations of money or property</li> <li>- Proceeds from sales of technical books, documents or other items</li> <li>- Money or property received in return for services rendered</li> <li>- Interest derived from CLT property</li> </ul>

No fee is charged to the farmers for attending the Jatropha School. Farmers are guaranteed fixed prices at sale for their goods by the Co-operative as follows: \$0.20/kg seeds, \$0.01/kg hulls or leaves or stems. During the first year, farmers are allowed to grow 200

plants each so that they can gain adequate experience. This number can increase in the second year up to a maximum of 800 plants generating a total income of about \$395. With an average annual price of production of \$183, each farmer makes a profit of just

over \$180 dollars. Annual loans from the Co-op to farmers total around \$28,500. Each farmer receives an annual loan of \$60 which has to be paid back within the year at a rate of 5-6% interest (1-2% less than that of a commercial bank). Farmers must pay all other costs of production. The Co-operative is responsible for formalising arrangements between members, for holding regular Committee and members meetings to ensure good governance and transparency and for providing technical support to the project. The daily income generated by the Co-operative from selling

Jatropha products is about \$580 from: biodiesel (\$172), organic fertilizer (\$287) and charcoal (\$125). On this basis, total annual income for the Co-operative is \$211,230. Annual production costs of \$167,360 are made up of materials (\$228 per day), processing (\$114 per day) and marketing (\$114 per day). Average profit from Jatropha products is therefore \$43,940. Currently all revenue is generated by and stays within the Co-operative. Sales external to the Co-operative are expected only when production is increased.

## Analysis of Livelihoods Outcomes

In terms of human capital, the farmers have gained new knowledge in farming and management techniques. Farmers also now have a good understanding of the entire market chain. Furthermore, farmers have utilised new technologies to improve crop yield. Women's involvement in the project has been key, with women taking responsibility for tasks including harvesting, raw materials preparation, and the processing of products.

With respect to natural capital, this project has helped decrease local environmental degradation through improved agricultural practices. Instead of using chemicals fertilizers and pesticides which used to contaminate local water supplies and leave toxic residues in the soil, farmers are now using organic fertilizer produced by Co-operative members. In some sloped areas, Jatropha plantations have reduced soil erosion. The plantations have also helped increase soil fertility and soil moisture content.

Formal agreements between farmers and other Co-operative members have strengthened social capital under a new formal status which increases their rights to get a better income from their main assets. These relationships have been reinforced by peer learning. Social capital has also been increased via job creation which has reduced migration of community members to the city.

Physical capital has been increased through the introduction of new technologies and machinery for pest and water management, fertilizer application, harvesting tools and processing machinery.

With respect to financial capital, cash flow analysis has shown that the Co-operative should be able to break even by the end of its second year of operation. Indirect financial benefits of this project have been experienced by fruit and vegetable producers, who have obtained on average 30% more for their organic products

## Overall Conclusions

Key to this project has been the insulation of the entire market chain within a Co-operative that has provided financial incentives for its members to take part by fixing and guaranteeing prices for buying/selling raw materials and end-products. In order for the project to sustain this success efficiency of equipment will need to be improved, along with an increase in producer numbers.

In addition to generating important financial returns for members, the project has also increased food and energy security. Once the revenue has been raised, a micro power plant will provide low-cost renewable energy to thousands of households in the District and assist communities to reduce their dependence on expensive imported petroleum. Income generating activities are expected to increase once market research for additional Jatropha products has been

conducted. Food production is expected to increase thanks to lower production costs.

The main success of the project has been to secure beneficial working relationships along the entire market chain from seed producers to end consumers. The take-up from farmers has been sufficient for the project to gain credibility from its success. It is hoped that this particular model for community Jatropha development will be taken up by other communities in Viengsa Agricultural Co-operative. If the model is successfully scaled-up, there are plans for it to be recommended to central Government to be incorporated into a national plan for community-based biofuel development. It is anticipated that this model will assist the country in meeting the biofuel targets set out in the Government's two roadmaps, as well as promoting environmentally sound farming practice.



<b>Initiative Name</b>	<b>Case 15 - Vietnam Farm Biogas</b> <i>Development of biogas market in Thanh Hoa province</i>
<b>Location</b>	<i>Thanh Hoa province, Viet Nam, Asia</i>
<b>Initiation Date and Duration</b>	<i>From July 2006 to date</i>
<b>Funder</b>	<i>Enabling Access to Sustainable Energy program (EASE) of the Organisation for Educational Training Consultants (ETC) of Netherlands (<a href="http://www.etc-international.org/index.php?id=41">http://www.etc-international.org/index.php?id=41</a>)</i>
<b>Project Initiator</b>	<i>Center for Rural Communities Research &amp; Development (CCRD)</i>
<b>Overall Budget</b>	<i>ETC support: 73,980 Euro . Contribution of beneficiaries: 56,850 Euro</i>
<b>Energy Output</b>	<i>504,000 m<sup>3</sup> biogas for cooking and lighting . (Estimated: 900 m<sup>3</sup> of biogas per household per year )</i>
<b>Area of Land Under Cultivation</b>	<i>None</i>
<b>Beneficiaries</b>	<i>560 households using biogas as free fuel in this province (9870 is the total number with biogas units across all 61 VACVINA chapters)</i>

## Background and Context

The Vietnamese economy has been one of the fastest growing economies in Asia over the last two decades. Its dramatic transition and growth have been attributed to a series of reforms, known as Doi Moi which began in the late 1980s. The reform process was initiated to replace the centrally planned and subsidised economy by a market-oriented system. Economic growth at nearly 8% per year has reached all socio-economic groups, benefiting the poor and reducing poverty from 58% in 1993, to 28% in 2002, and 18% in 2007.

Within the agricultural sector, a Vietnamese farmer's conditions have improved dramatically, mainly through the allocation of land to peasants. Farmers are encouraged to manage their own family plots. The Vietnamese have developed a concept of integrated farm management, and the Vietnamese Gardener's Association (VACVINA) has national responsibility to promote this concept – called the VAC integrated system. VAC refers to a form of small-scale bio-intensive farming where gardening, fish rearing and animal husbandry are closely integrated. VAC makes optimal use of land, water and solar energy to achieve high economic efficiency with low capital investment.

With a high population density, there is a need to use environmentally friendly renewable energy sources whilst retaining agricultural production, and to avoid forest depletion which adversely affects land productivity through drought, flooding and erosion.

Traditional fuels such as wood and coal for cooking are becoming increasingly scarce and expensive, and can contribute to deforestation. The forest depletion rate in Vietnam is more than 4% per year.

In Vietnam, 80% of households engage in farming and agricultural waste poses a threat to the environment due to fresh animal dung being discharged into open gutters and community waterways. An increasing population leads to intensive agricultural practices, damaging the environment. The treatment of animal and human waste by biodigestion is one method introduced to address these issues. It increases the production and use of renewable energy, is a safe treatment for human and animal waste, reduces deforestation, increases the capacity of farmers to supply more food, and supports the livelihoods of farmers and vulnerable people.

Vietnam is divided into provinces, districts, communes and wards. A commune has a population of 1,000 to 2,000 households. Phu Loc is one of 26 communes in the Hau Loc District of Thanh Hoa province, the second largest province in Vietnam. Located in the North-Central region, it has a population of nearly 4.5 million of which 80% is rural.

From August 2006 a market-oriented approach was adopted to introduce biogas systems, with support from the ETC/EASE program. Phu Loc - one of 20 project communes, has 1720 households. Currently 80

households use biogas. Depending on the quantity of dung (pigs, cows, buffalo), the households have been consulted, and provided with bio-digesters by local suppliers. Some households have received 18-25%

discount of total cost of biogas plants as an “early bird” promotion, offered by local biogas service providers. Others have paid full market price.

## The Initiative Market Map

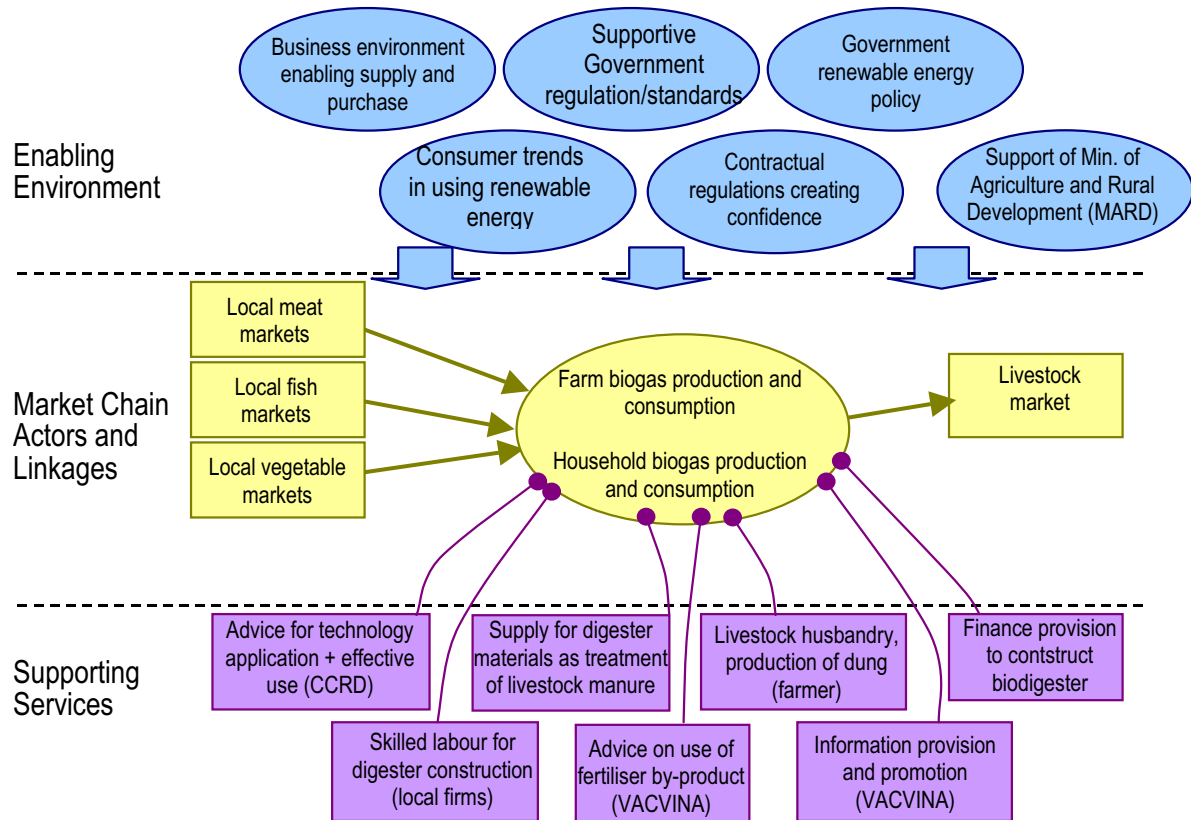

The CCRD initiative has been based on market-oriented approach in order to build a network of autonomous product providers for sustainable biogas development. This is the first cooperation between CCRD and ETC/EASE of Netherlands for Enabling access by market orientation in Vietnam for sustainable energies to the poor.

A biogas digester produces enough daily fuel for cooking and lighting. It improves the surrounding environment, whilst livestock produce meat, milk and fish products for local consumption and subsistence farming. Vegetable production is enhanced through use of biogas slurry - a high value bio-fertilizer. Thus, farmers and households provide all the inputs and use all outputs.

CCRD is one of the most active NGOs and is responsible for VACVINA's main activities and targets; promoting animal husbandry, providing equipment to biogas service providers, and perfecting the 'VAC system' as a closed production system without waste.

VACVINA has a network of offices at commune level most are involved in retailing farm supplies and equipment. VACVINA branches, after training, lead biogas market development as service providers, that to satisfy the demand of the potential customers who have atleast 5-7 pigs or 2-3 cattle. Using local available materials (bricks, cement, sand, stone...) the household biogas digesters offered by providers will be designed for different sizes based on quantity of animal dung (quantity of animals) that needed to be treated in every household daily. The main maintenance will be required after 4-5 years only for emptying slurry as a sediment at bottom of digesters. This could be done easily by household as the case of the maintenance for a septic tank that when-known in rural of Vietnam.

The VACVINA biogas model, designed by CCRD, was recognised by MARD who decreed that it could be installed nationwide. CCRD promoted biogas technology through the local network of VACVINA offices. The VACVINA provincial chapter is responsible

for continuous monitoring and support at commune level, supervised at district branch level. Supervised by the provincial chapter, district chapters are responsible for monitoring suppliers and managing credit for commune level providers. Biogas service providers take responsibility for the sale, construction and installation of turn-key biodigesters, training clients and honouring the warranty to households and farmers.

The peri-urban and rural households and farmers must have at least 4-6 pigs or 2-3 cattle which provide all the inputs (animal dung). Households use the biogas as fuel and slurry as fertilizer. They pay the total installation cost for the digesters to local service providers, and operate the biodigester using instructions provided by local service providers.

## Relationships between Market Actors

	Farmers	Biogas service provider	VACVINA groups	CCRD	MARD
Farmers					
Biogas service provider	Technical, financial and formal				
VACVINA	Technical, financial and formal	Technical, Regulatory, formal			
CCRD	Informal, technical	Technical, formal	Technical, formal		
MARD - Ministry of Agriculture / Rural Development.-	Regulatory, financial, Informal	Regulatory, Informal	Regulatory, Informal	Regulatory, Informal	

## Balance of Rights, Responsibilities and Revenues

Actors'3Rs'	Rights	Responsibilities	Revenues
Small Farmers Large Farmers	<ul style="list-style-type: none"> <li>- Use of land for farming including animal raising</li> <li>- Sales of animals (pigs, cows, buffaloes) for meat and milk products etc</li> </ul>	<ul style="list-style-type: none"> <li>- Protect the environment via agriculture production</li> <li>- Paying back loans if any</li> <li>- Operating and maintaining digesters while cleaning pigsty</li> </ul>	<ul style="list-style-type: none"> <li>- Income from farm products.</li> <li>- Saving money using biogas as a free fuel</li> <li>- Saving money by using slurry as a fertilizer</li> </ul>
Biogas service providers	<ul style="list-style-type: none"> <li>- Rural and agricultural service provision</li> </ul>	<ul style="list-style-type: none"> <li>- Promoting biogas installations for sustainable rural and agricultural development including fertilizer</li> </ul>	<ul style="list-style-type: none"> <li>- Income from selling biodigester and/or wages building biodigesters</li> <li>- Income providing bio-additive to farmers for producing biofertilizer</li> <li>-</li> </ul>
CCRD -NGO as National technical assistance Center, on VAC promotion including biogas	<ul style="list-style-type: none"> <li>-Research &amp; Development of advanced technologies including biogas.</li> <li>-Enabling access to sustainable energy to reduce poverty</li> <li>-Providing information, consulting and training</li> <li>-Improving community management capacity</li> </ul>	<ul style="list-style-type: none"> <li>- Enforcing VACVINA regulations regarding its objective on promoting VAC integrated system including biogas technology</li> </ul>	<ul style="list-style-type: none"> <li>- Income providing bio-additive to farmers for producing biofertilizer</li> <li>- Income from selling tools and biogas equipment</li> </ul>
VACVINA chapters at all level	<ul style="list-style-type: none"> <li>- Developing VAC integrated systems with farmer groups, including animal husbandry</li> <li>- Policy advocacy with reference to farmer's rights</li> </ul>	<ul style="list-style-type: none"> <li>- Enforcing VACVINA regulation, revised every 5 years to include responsibilities assigned to relevant chapters &amp; NGOs under VACVINA</li> </ul>	<ul style="list-style-type: none"> <li>- Income from Association member fees.</li> </ul>

VACVINA branches at commune level have the rights to rural and agricultural service provision. They lead biogas market development as biogas service providers, and train on the technical aspects. Their responsibilities are to: stimulate interest and demand; receive marketing and technical training; plan and implement the marketing campaign; contact clients and sign turn-key biodigester contracts; supply all necessary materials; liaise with CCRD for tools and biogas equipment; mobilise teams of builders; train the user; guarantee the product. Providers give a 5-year warranty on defects under normal usage on all components. Revenue is through selling biodigesters, bio-additives for biofertilizer production as CCRD agents and other retailing farm supplies and small equipment. Membership fees help to support the organisation to manage its activities. Technicians selling and installing are paid on a 'per unit installed' basis. They do not receive a salary from the local provider. Additional workers are recruited locally and paid for masonry work by negotiation. The costs of local promotion, technical support and warranty are covered by the profits generated from sales.

VACVINA provincial & district chapters have the right to convene farmers for VAC integrated system development training, including animal husbandry. Given the number and dispersed nature of the districts and communes, the VACVINA provincial chapters are responsible for continuous monitoring and support to

## Analysis of Livelihoods Outcomes

Although farmers do not receive an income directly from biogas, the digesters do contribute to an increase in **Financial Capital** as follows:

*Generating more income from animal raising:* Without the support of a biodigester, a household can raise 1-2 pigs or one cow/ buffalo only to avoid contamination by animal waste. With a biodigester, the environment is protected, so a household can raise more animals and generate more income. For some households, animal husbandry will bring in 60-75% of their total income.

*Saving fuel:* Biogas replaces firewood and coal for the entire family's needs for cooking and electricity for lighting produced by a generator using biogas. This represents a direct yearly saving of \$80 to \$200 for those previously buying all their fuel.

*Saving time in gathering firewood:* The time saved from not having to gather fuel (from 50 to 90 days /person /year), can be channelled to income generating activities.

the commune level providers. Supervised by a provincial chapter, they monitor the activities of biogas providers, participate in training sessions and manage credit facilities for commune level suppliers. Part of the revenue of province and district level VACVINA chapters comes from membership fees. The remaining income comes from consulting services to Government Agriculture development projects.

CCRD have research and development rights for advanced technologies for sustainable rural and agricultural development including biogas. CCRD is responsible for providing access to sustainable energy including biogas, providing information, consulting, training and improving community management capacity. CCRD also provides suppliers with materials, tools and equipment and liaises with representatives of VACVINA chapters to oversee in more detail the activities of local VACVINA chapters. Revenue for CCRD comes from selling tools and biogas equipment, bio-additive to farmers for producing biofertilizer, and consulting services to national development projects.

Households & farmers' rights enshrined in the *Doi Moi* reforms to allocation of land, farmers include selling of animals (pigs, cows, buffaloes, etc) and meat, milk and vegetable products at market. They can earn money through selling cooked products for which they used biogas as a free fuel. They can use biogas slurry as fertilizer, saving money avoiding chemical fertilizers.

*Sustainable Agricultural Practice:* Fertilisers generated by the bio-digestion process have high nutrient value, and are safe to use on fruit trees, fishpond, rice paddies and vegetable gardens and are preferable to chemical fertilizers.

*Installing a hygienic latrine* is beneficial for families without latrines. A bio-digester can be coupled with an energy-generating latrine using human waste. The latrine is a fraction of the cost of a regular installation.

*Additional income* and prestige is achieved by local VACVINA chapters, including technicians and local masons, by providing turn-key biodigesters through the extra paid employment and service to the community.

*Biogas has also been shown in this initiative to improve community relationships*, increasing **social capital**. A specific community culture in Vietnam has existed for thousands years requiring families "to preserve good relationships with your neighbours" so that your family is well regarded. Animal and poultry-raising activities help many households to improve their income, but in

the overcrowded areas of rural Vietnam, animal waste poses health threats and neighbours suffer from the bad smells. The clean environment created by using biogas contributes to improved relationships.

The large membership of VACVINA makes use of this social capital in scaling up this initiative. The 1986 Doi Moi economic reforms in Vietnam provided farmers with land – albeit with very small plots. Without knowledge, investment capital, seeds or tools, families could not escape poverty due to inefficient traditional farming methods. VACVINA trained farmers in improved agricultural practices. Farmers started growing efficiently, generating better income and gradually reducing poverty. VACVINA became a reputable and well-known Vietnamese organisation.

The current initiative provides the most cost-effective, reliable model for households wishing to purchase a biogas plant, which is part of a wider family of products (BiOVAC additive to produce bio-fertilizer) and the intensive VAC agriculture model.

**Natural capital** is protected and enhanced through a *reduction in forest felling*. It is estimated that in Vietnam, woodfuel consumption averages 1.5kg per day (500 kg /year /person). In some areas, the figure is much higher (around 1500 kg per person per year – *Report of Vietnam Forest science Institute -1996*).

With respect to *greenhouse gases*, CCRD's calculation shows that a biodigester can capture an average 2.5 cubic metres of methane per day, or 900 cubic metres per year per digester.

*Safe and proper treatment of animal waste*: The human and animal waste treated by the biodigester meets all criteria required by Government standards on BOD (biological oxygen demand) and COD (chemical

oxygen demand). In rural communities, the slurry produces no contamination of water or land from animal wastes.

**Human capital** is developed through a combination of health and sanitation improvements. Biodigesters improve general sanitary conditions on family plots. To collect the manure, animals are kept in pens or cages, reducing the health hazards related to free roaming animals.

Pens are also kept much cleaner by the daily removal of the manure required for biodigester operation. The foul smell, especially from pigsties, is greatly reduced, as the biodigestion process is anaerobic and smell-free. Disease-carrying flies and parasites are also reduced.

*Safe agricultural products*: The use of biodigester effluent as a fertiliser for the fishpond or garden, as opposed to green animal manure, produces fish, fruits, and vegetables that are safer for human consumption.

Biogas is a very clean and efficient energy source, free from the hazardous smoke and gases produced by wood or charcoal. Women typically assigned to the daily cooking chores have repeatedly reported the benefits of biogas on their immediate environment. Most women have also cited the time saved from scrubbing soot-covered pots and pans as an important advantage of biogas cooking.

In terms of **physical capital**, the availability of an inexpensive but rich organic fertiliser reduces the costs and risks associated with chemical fertilisers (overuse, product contamination, and leakage into wastewater). The use of biodigesters promotes effective and healthy recycling of existing biomass resource, and encourages the sustainable agricultural practices promoted by the VAC project.

## Overall Conclusions

The initiative appears to have had a positive effect on rural stable livelihoods. Biogas complements sustainable agricultural production in the animal husbandry sector, generating additional income, protecting the local environment and enabling access to sustainable energy for the poor. Biogas is an essentially free resource that can replace traditional fuels (coal, firewood, rice straw etc). Local service providers benefit through new employment opportunities and enhance their income.

The main success factor of the biogas project in Thanh Hoa has been based on the Enabling Access to Sustainable Energy program, a 5-step market orientation strategy (ETC/EASE) focused on enhancing

capacity building of community-based organisations with relevant necessary skills. Otherwise, the biogas project impact would have been similar to others based on an NGO-subsidized approach and would probably have failed once the programme ended.

Insufficient money to buy a household biodigester has been identified as one factor that limits biogas development in the community. Biogas use requires farmers to pay even more if they wish to incorporate hygienic latrine. Currently, there are insufficient finance mechanisms through which farmers can access credit for building VACVINA biogas plants. The demand is still immense as Vietnam has nearly 10 million households involved in various forms of animal husbandry.

## 7.2 List of Contributors

Case Study Project Manager – Steven Hunt (Practical Action Consulting)

FAO Project Manager – Olivier Dubois (Climate Change and Bioenergy Unit – NRCB)

For More information about specific cases contact [info@pisces.or.ke](mailto:info@pisces.or.ke) in the first instance to be directed to the appropriate individual.

	Region	Country	Case	Lead Author(s)	Case Manager /QA	Contributors /Editing
1	W Africa	Mali	Mali Jatropha Electrification	Ousmane Ouattara	Dr Smail Khennas	Ibrahim Togola
2	W Africa	Senegal	Senegal Chardust Briquettes	Mireille Ehemba	Dr Smail Khennas	
3	W Africa	Senegal	Senegal Typha Charcoal	Mireille Ehemba	Dr Smail Khennas	
4	E Africa	Tanzania	Tanzania Sisal Biogas	Virginia Harden	Steven Hunt	
5	E Africa	Tanzania	Tanzania Palm Oil	Dr Tom Molony	Steven Hunt	
6	E Africa	Kenya	Kenya Charcoal Afforestation	Dr Fridah Mugo	Tameezan Wa Gathui	
7	E Africa	Ethiopia	Ethiopia Ethanol Stoves	Milkyas Debebe	Dr Ben Muok	
8	S Asia	India	India Jatropha Electrification	Santosh Kumar Patnaik	Dr A Nambi	
9	S Asia	India	India Biodiesel Waterpumping	Santosh Kumar Patnaik	Dr A Nambi	Ramani Sankaranarayanan
10	S Asia	Sri Lanka	Sri Lanka Biomass Spice-Drying	Upamali Surangika	Ramani Nissanka	Becky Clements
11	L America	Brazil	Brazil Ethanol Micro-Distilleries	Regina Couto	Angela Higuera	
12	L America	Guatemala	Guatemala Jatropha Biodiesel	Marta Rivera	Angela Higuera	
13	L America	Peru	Peru Veg-Oil Recycling	Gaston Lopez, Maria Lozano, Fernando Acosta	Angela Higuera	
14	SE Asia	Thailand	Thailand Jatropha Co-operative	Becky Clements	Steven Hunt	Prof Sombat Chinawong
15	SE Asia	Vietnam	Vietnam Farm Biogas	Pham Van Tanh	Ramani Nissanka	

### 7.3 ToR for the Overall Case Study Activity

#### Objective

To highlight cases in which local production and/or consumption of Bioenergy is bringing livelihoods benefits to rural communities, and learn lessons about how these benefits have been realised. In this way to bring the rural livelihoods side of Bioenergy into the international debate.

#### Background

Rural development is often seen as one of the main factors driving the interest in Bioenergy, alongside high energy prices, energy security and climate change. Indeed, Bioenergy has significant potential to promote rural development and contribute to poverty reduction, especially when it uses locally-produced feedstock, through:

- Wider and more on-demand availability of energy, with all its related services for local development (for households, communities and productive uses)
- Job creation, both directly and indirectly, and especially for bioenergy projects based on agriculture
- An alternative in terms of agricultural production, thus contributing to income diversification for farmers
- As a result of the above, increased local revenue generation

However, developing Bioenergy systems that contribute to poverty reduction as well as enhancing energy, food and water security is a complex challenge. Understanding the true impact of Bioenergy Systems on rural livelihoods requires improved understanding of the nature of the complete market chains, and of the different business models, technologies, institutional arrangements and policy drivers at the various stages in the chain, which can lead to very different livelihoods outcomes. PISCES conceptualises Bioenergy systems as energy pathways which may be illustrated as below:

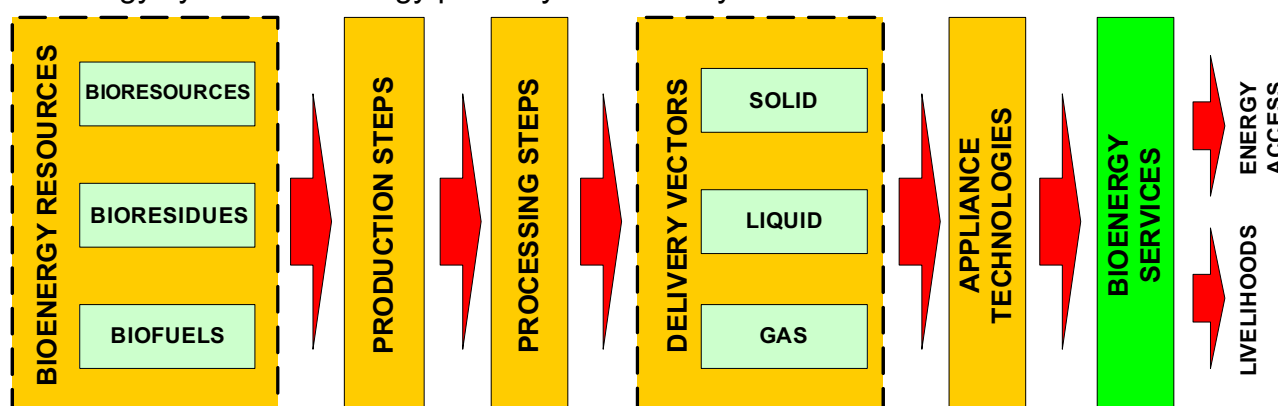

This diagram shows the various Bioenergy Resources and how they are converted ultimately into energy access and livelihoods outcomes. However, not only does the use of the energy result in livelihoods opportunities via energy access and productive uses, but each step and sub-step in the system (as well as wastes and co-products) represents a separate livelihoods opportunity and has its own interlinked characteristics in terms of possible technologies, capacities required, financial implications, institutional arrangements, governance issues, access rights, risk characteristics, environmental impacts etc.

This study sets out to better understand these existing systems, how they have evolved, what constraints they face, and the extent to which different approaches really do enhance rural livelihoods. In this way the study hopes to synthesise lessons about what elements and approaches might be incorporated in future project designs and policy frameworks, so as to maximise the beneficial contribution of Bioenergy to rural livelihoods.

## **Scope**

The cases should highlight a range of feedstocks (Bioresources, Bioresidues and Biofuels) but with an emphasis on the new field of liquid biofuels and “modern” energy conversions from other forms of Bioenergy. The cases should cover a cross section of end-uses including electricity, cooking/heat and mechanical power. The cases should cover Latin America, West Africa, East Africa and South Asia with a minimum of 3 cases from each region.

## **Tasks**

This will be primarily a desk study although where possible field visits may be undertaken or notes from previous field visits used. Tasks undertaken will be as follows:

- Conduct a brief Literature Review and finalisation of methodology and Case Study selections from Africa, Asia and Latin America which can provide insights and lessons into the practical, technical and institutional challenges and opportunities of Small-Scale Bioenergy Initiatives and their contribution to rural livelihoods in particular.
- Within each Case Study:
  - Conduct Market Chain Analysis (participatory where possible) to establish the full extent and features of the Bioenergy market chain
  - Conduct 4R’s analysis of the Relationships and balance of Rights, Responsibilities and Revenues at each stage of the Market Chain and between actors including those in the Enabling Environment and the Supporting Service sectors.



- Conduct Livelihoods Assessment of both the Vulnerability Context and the Livelihoods impact of the chain on each participant group
- Draw conclusions on the extent to which the initiative contributed to rural livelihoods and lessons as to how this has been achieved
- Analyse and compare Case Studies to highlight:
  - Common factors and inconsistencies between initiatives and livelihoods outcomes especially regarding types of Bioenergy, Resources, Management/Business models, technologies used, cost efficiency, policy environments, institutional arrangements and stakeholders' '4Rs'.
  - General lessons and conclusions based on the case studies
- Submit a draft consolidation report to IDWG-Bioenergy and PISCES during a one-day workshop to be held in Rome
- Include comments on the draft in the final version of a consolidation report and submit to the NRC Director and PISCES Research Director.

## **Deliverables**

Deliverables from the Case Study project will be as follows:

- Inception report: Structure of main report, methodology and final titles and outline of case studies – 5<sup>th</sup> September 2008
- Draft Case Studies and Consolidation Report – 25<sup>th</sup> October 2008
- Presentation workshop at FAO including Powerpoint Summary – week of 27<sup>th</sup> October 2008
- Final Consolidation report including Case Study annexes – 15<sup>th</sup> November 2008
- Joint FAO/PISCES Policy Brief – By end 2008 (not included in this agreement)

Case studies will be 5 pages each and according to the agreed Case Study Template. Case studies will be attached as Appendices to the final report which will be 25-40 pages in length.

Deliverables will be provided on schedule to the Director, Environment, Climate Change and Bioenergy Division at FAO, and the Research Director of the PISCES Research Programme Consortium.

## 7.4 Case Study Template

### Case Study Template – 5 PAGE LIMIT

<b>Initiative Name</b>	
<b>Location</b>	<i>Town, Country, Region</i>
<b>Initiation Date and Duration</b>	<i>Date and duration in years</i>
<b>Funder(s)</b>	
<b>Project Initiator</b>	
<b>Overall Budget (if available)</b>	<i>In US\$</i>
<b>Output</b>	<i>Eg In kWh per annum or other if not applicable, please specify</i>
<b>Area of Land</b>	<i>Eg under cultivation in Hectares</i>
<b>Beneficiaries</b>	<i>Numbers – Group – Benefit Eg. XXX Farmers – Income, XXX Households – Electricity etc</i>

### Background and Context

*Introduction to the town, country and region context and background.*

*Describe in particular the Vulnerability Context relevant to the initiative such as Trends (population, resources, conflict, economics, governance and technology), Shocks (Human Health, natural disasters/risks, economic shocks, conflict, crops/livestock) and Seasonality (of prices, production, health and employment). For more information on describing the Vulnerability Context see: [http://www.livelihoods.org/info/guidance\\_sheets\\_pdfs/section2.pdf](http://www.livelihoods.org/info/guidance_sheets_pdfs/section2.pdf)*

*Narrative introduction to the initiative, main players, phase of the initiative etc. Has there been evidence of natural scale-up, are there plans for this or is the project currently at pilot stage?*

*Description of the financial situation of the project eg self-sustaining, ongoing subsidies in place, project funding support only. What is the financial profitability of the system, what is the proportion of subsidised and self-financing? Proportion of public and financial capital involved in the scheme?*

## The Initiative Market Map

Each case study should have a market map produced for it to the fullest extent possible in the format below. Ideally this would be done through a participatory market mapping process but if not it may be produced from consultation with market actors or from existing knowledge of the project (with the source noted). For guidance on completion see: [http://practicalaction.org/docs/ia2/mapping\\_the\\_market.pdf](http://practicalaction.org/docs/ia2/mapping_the_market.pdf)

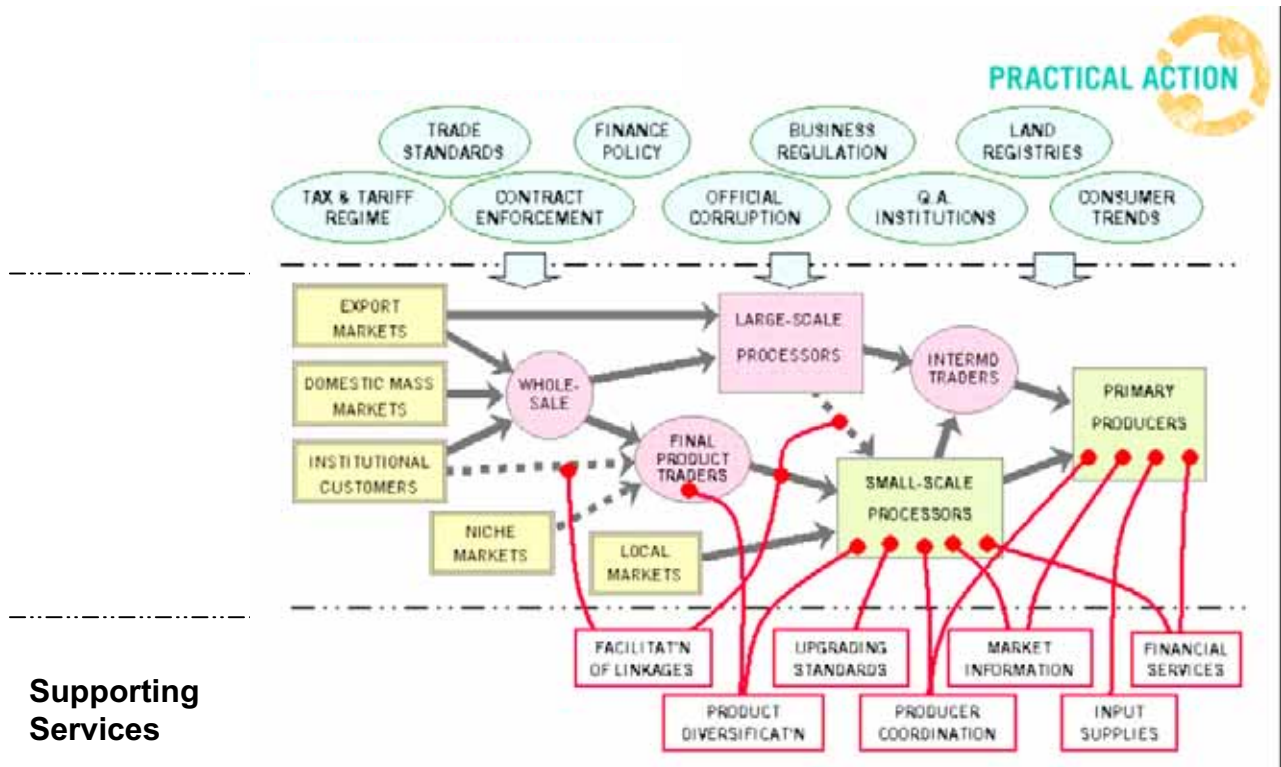

Provide narrative description of the Market Map including interesting or unusual features. Note features which are specific to the project/initiative

design intent and features which have evolved naturally. Note use of any co-products and wastes as well as the main chain.

## Relationships between Market Actors

Complete the example table below describing the relationships between the various actors identified in the Market Map above (replace existing sample inputs). Highlight key types of relationship such as Technical (support and knowledge sharing), Financial (purely commercial), Regulatory (incentive or legally driven), Informal as well as any other relevant types. For guidance on completion see: [http://www.policy-powertools.org/Tools/Understanding/docs/four\\_Rs\\_tool\\_english.pdf](http://www.policy-powertools.org/Tools/Understanding/docs/four_Rs_tool_english.pdf)

	Eg Farmers:	Eg Woodcutters	Eg Charcoal traders		
Eg Farmers:					
Eg Woodcutters	Eg Poor, Informal				
Charcoal traders	Eg Poor, Informal	Eg Financial, Informal/formal			

*Provide narrative description of the relationships between the market actors highlighting instances where the initiative has broken down relationship barriers to enable progress, methods used by the*

*project to forge or improve relationships, public-private partnerships and institutional arrangements such as co-operatives, associations and forums etc*

## Balance of Rights, Responsibilities and Revenues of Market Actors

Complete the table below replacing the example inputs with the various actors listed down the left hand side and their respective Rights, Responsibilities and Revenues with regards to the initiative. For guidance on completion see: [http://www.policy-powertools.org/Tools/Understanding/docs/four\\_Rs\\_tool\\_english.pdf](http://www.policy-powertools.org/Tools/Understanding/docs/four_Rs_tool_english.pdf)

Actors\ '3Rs'	Rights	Responsibilities	Revenues
Eg Small farmers	- Forest usage rights - Use of land for farming - Sales of forest products if allowed	- "Caretakers" of the land and natural resources	- Subsistence from the forest - Income from farm products and some forest products
Eg Woodcutters	- Cutting wood	- None	- Income from selling charcoal and/or wages from cutting wood
Charcoal traders	- Selling charcoal	- None	- Income from selling charcoal
Eg Forestry Service	- Collecting forest use fees	- Managing the forests - Enforcing regulations	- Income from forest use fees

*Provide narrative discussion of the allocations of rights within the initiative/case and how these affect actions, risks, security etc.*

*Provide narrative description of the distribution of responsibilities between the actors. These may be implied by their role, enforced by regulation or contracts etc. Discuss how these responsibilities are mirrored or not by Rights discussed in the previous paragraph. Draw conclusions from this on who carries which risks.*

*Provide a narrative, and where possible quantified, description of the revenue flows between each stage of the market chain. Highlight any patterns in this flow such as seasonality.*

*Provide a brief assessment of the balance of rights, responsibilities and revenues of market actors and its implication on the market chain.*

## **Analysis of Livelihoods Outcomes**

*Summarise the livelihoods outcomes of the initiative drawing on the understanding presented of the various market actors involved with the initiative and their respective Relationships, Responsibilities, Rights and Revenues. How have the 5 Types of Livelihoods capital (Human, Natural, Social, Physical and Financial) for the actors in the market chain been affected by the Initiative and what is the sustainability of this change? Describe the Direct, Indirect and Feedback/Virtuous Circle contributions to these forms of capital. For more information on*

*quantifying and qualifying types of Livelihoods Assets see:*

*[http://www.livelihoods.org/info/guidance\\_sheets\\_pdfs/section2.pdf](http://www.livelihoods.org/info/guidance_sheets_pdfs/section2.pdf)*

*How have technical and Institutional aspects in particular affected the Livelihoods Outcomes?*

*Have there been any environmental impacts which may have had a circular impact on Livelihoods?*

## **Overall Conclusions**

*Has this project maximised its potential to support rural livelihoods? If not, why not? What blockages or interests mean that this does not happen?*

*What are the crucial failure and success factors?*

*What are the key factors affecting the sustainability of the initiative?*

## **References and Bibliography (not included within 5 page limit)**

*Provide full details of documents referred to, interviews conducted including dates etc*

## **Full notes and supporting documentation (not included within 5 page limit)**

*Provide all relevant interview notes, pictures,*